



High-performance, customised design

ACO balcony and terrace drainage



ACO. creating

the future of drainage

The worldwide ACO Group. A strong family you can rely on

The ACO Group is one of the global market leaders in the drainage technology sector. Climate change challenges us to come up with innovative solutions in response to new environmental influences. ACO adopts an integrated approach and focuses on professional drainage, efficient cleaning and the controlled drainage or reuse of water. The company's products comprise drainage channels and gullies, oil and grease separating systems, back flow systems and pumps as well as pressurised watertight basement and cellar windows and light shafts.

The family company, which is based in Rendsburg/Büdeltsdorf, was founded on the grounds of the Carlshütte, the first industrial company in Schleswig-Holstein, in 1946. The ACO Group's innovation capability is the result of intensive research and development and expertise in the processing of polymer concrete, plastic, cast iron, stainless steel and reinforced concrete.

ACO Building Drainage Building safety - from the tender to the service

We are your expert in all technical and planning matters for drainage solutions in buildings. With experience and passion, we will find the most rational and economical solution for you which meets all professional and standard requirements.

Whether for residential or industrial construction, hospitals, hotels or shopping centres: we provide tailor-made advice - both in the design and for special channels and connections to the floor sealing systems. If necessary, we will calculate the vacuum drainage and assist you in the selection and configuration of the products.

www.aco-haustechnik.de



Head Office of the ACO Group
in Rendsburg/Büdeltsdorf



5,200

Members of staff in more than 47 countries (Europe, North America and South America, Asia,

1 billion

Euros turnover 2021

37

Production locations in 18 countries



ACO Academy
for practical training

Proprietor
Iver and Hans-Julius Ahlmann



Balcony and terrace drainage

Whether it's a light shower or heavy rain: If the rainwater on the surface of balconies and terraces is not drained away, the moisture can permanently damage the structure of the building. The planning and implementation of balcony and terrace drainage therefore requires maximum care from architects and installers, individual customisation and consequently a drainage system that is perfectly matched to the installation location.

In order to meet the high demands for flexibility and safety, ACO Building drainage has developed a standard-compliant range for the drainage of balconies and terraces, which includes tailor-made solutions for different floor structures and building heights. Whether it's a balcony slab made of waterproof concrete or a terrace in the form of a

reversed roof, balcony waterproofing with liquid plastics or waterproofing membrane, with or without insulation: the easy-to-install balcony range made of stainless steel 1.4301 in combination with the GM-X piping system is based on a modular principle and is suitable for both new buildings and renovations.



Modular construction

A variety of drains and versions for connection to the bonded seal, combined with the appropriate accessories, enable custom-fit solutions for every installation situation.

Manhole covers

There is a choice of gratings and sieves for upper balconies and for running the downpipe through balcony floors.



Flange connections

Balcony drain with optional adhesive flange, compression seal flange or wall flange for direct connection to existing building components. Suitable for liquid plastic, plastic membranes (PVC, FPO) or bituminous waterproofing membranes, depending on the type of flange.

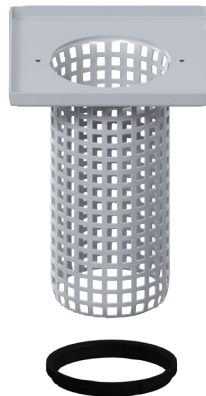

Grating holders for balcony superstructures

Grating holder available with sieve holes or as standard grating holder in PE or stainless steel. Can be shortened as

Overall heights

Various heights between 120-300 mm available.

Always fits: The gullies can be cut to the required thickness of the balcony slab on site.



Balcony drain

Balcony drains made of corrosion-resistant stainless steel 1.4301 in various nominal widths from DN 50 to DN 100 - with optional vertical or lateral outlet.

Practical casing bell

Balcony drains with a bell are gullies with an additional sleeve pipe. The gully can therefore be concreted flush directly into the balcony slab. This saves working time and costs, as there is no need for additional formwork or core drilling on site.

Downpipe

Matching GMX pipe system and fittings for each connection variant.

Suitable solutions for every balcony

Basic structure of the balcony



Balcony without waterproofing membrane



Balcony with waterproofing membrane

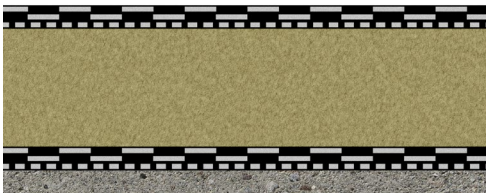

Balcony with waterproofing membrane and thermal insulation



Balcony with waterproofing membrane, reversed roof



Balcony with liquid plastic or bituminous waterproofing membrane

Matching balcony drains



Balcony drain



Balcony drain with compression seal flange



Balcony drain with compression seal flange + bottom part



Balcony drain with compression seal flange



Balcony drain with adhesive flange

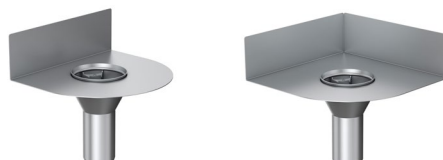

Balcony drain with wall flange

Types of drainage

Balconies can be drained in two ways. Either via individual drains with pipe installation to the downpipe or with direct drains to direct the downpipe through the balcony drain.

Single drain

Single drains are used if the rainwater is to be discharged into the downpipe via a single drain. Balcony drains with lateral outlets are concreted directly into the balcony slab. For balcony drains with vertical outlets, the pipe can be routed horizontally under the balcony to the downpipe.

1

Balcony with liquid plastic

Balcony drain with adhesive flange and lateral outlet concreted into the balcony slab

2

Balcony with raised slabs

Balcony drain with compression seal flange and vertical outlet

Direct drainage

Direct drains are used when rainwater is to be discharged directly into the downpipe from the balcony above. Cost savings due to less pipe and fastening materials and quick installation.

3

Balcony drain with wall flange

Balcony with liquid plastic, gravel fill and panels in the thermal insulation composite system



Combinable modular system

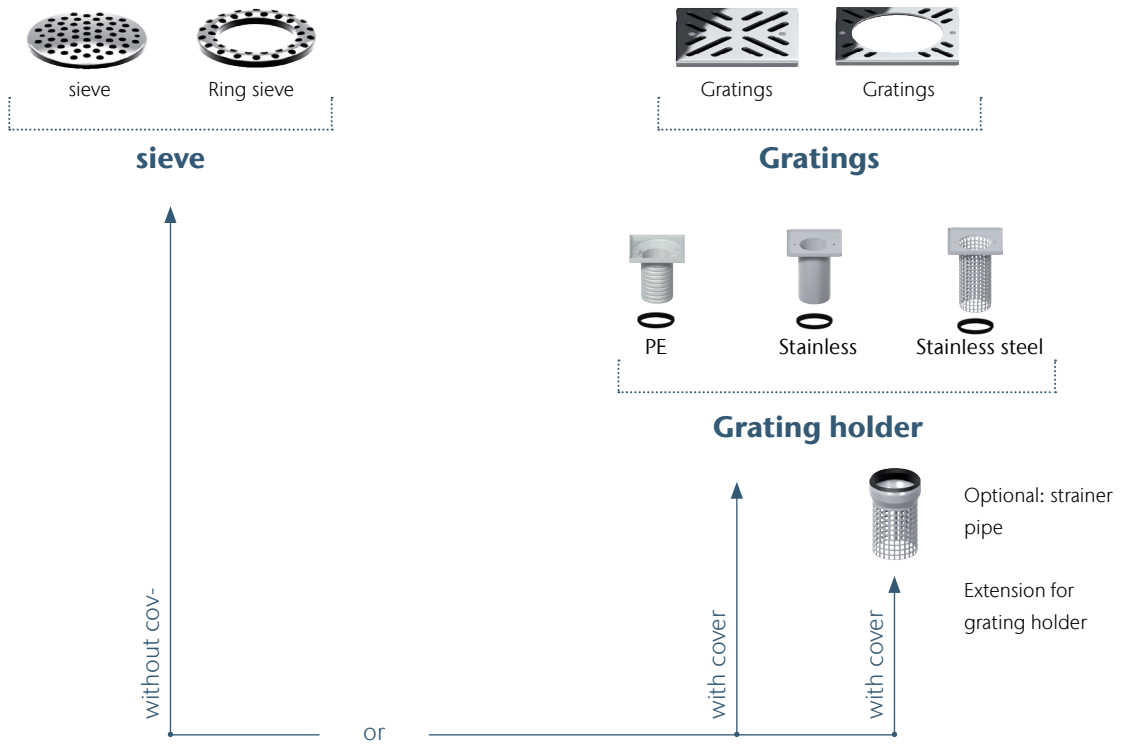

Balcony drain

with bell

Balcony without waterproofing membrane

Balcony drain with compression seal flange

+ Bottom Insulation casing

Available as an option for the connection of a 2nd waterproofing

Balcony with waterproofing membranes

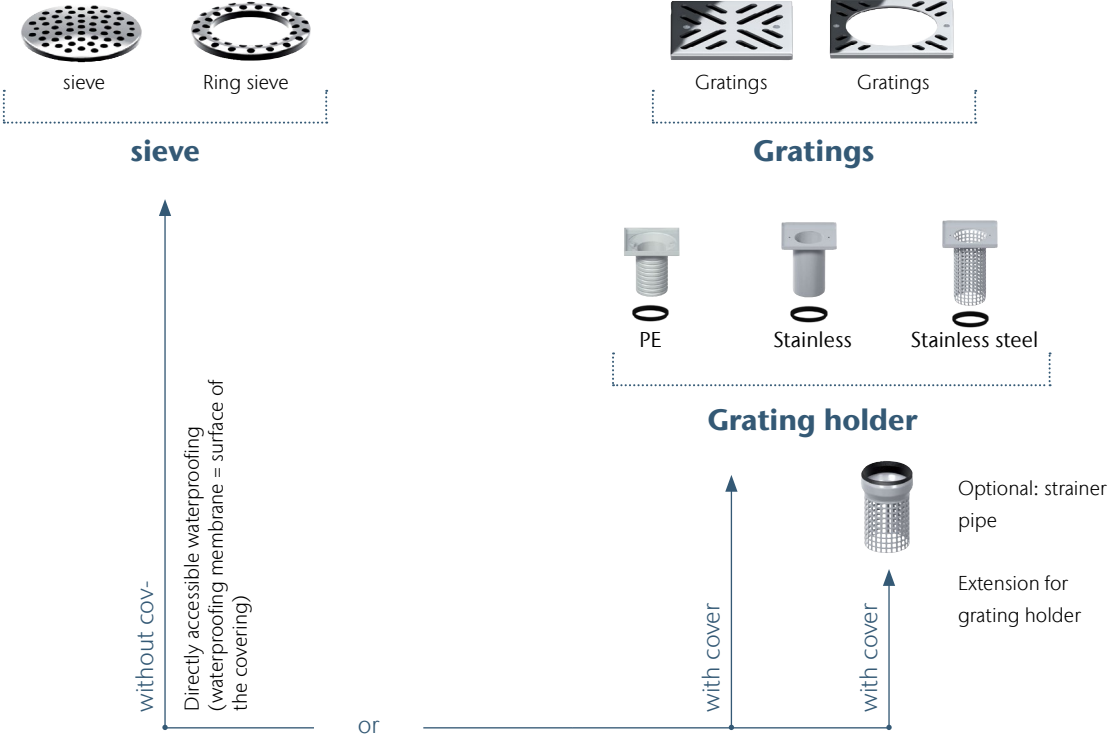

Balcony drain with adhesive flange

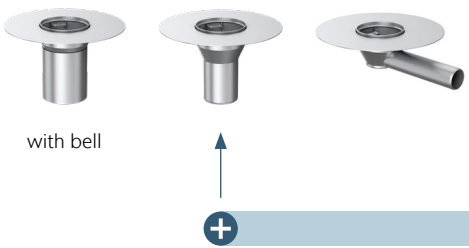

Balcony drain with corner wall flange + wall flange

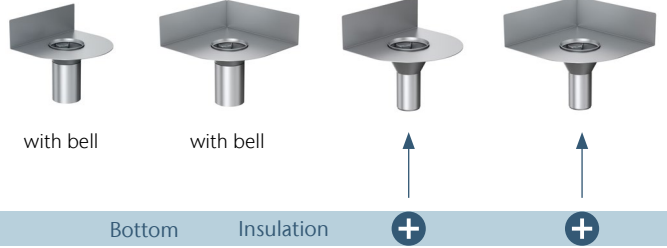

Available as an option for the connection of a 2nd waterproofing

Balcony with liquid plastics or bituminous waterproofing membranes



ACO Balcony drain



Suitable for balconies without waterproofing membrane

Product information

- can be used as single or direct drain
- small core drillings Ø: DN 50 / DN 70 with 130 mm, DN 100 with 150 mm
- made of corrosion-resistant stainless steel 1.4301
- Available with optional bell for direct cementing into the balcony slab

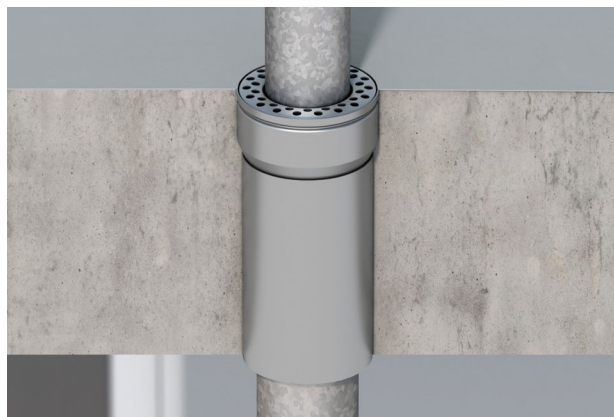







Balcony drain with bell for installation into a balcony slab without waterproofing



Balcony drain with lateral outlet for installation in a balcony slab without waterproofing

Ordering information

	Nominal diameter	Discharge capacity	Height	Article No.	Gross prices
		[l/s]	[mm]		[€]
ACO Balcony drain					
	DN 70	5.5	200	0174.58.40	62.40
	DN 100	7.0		0174.58.50	82.20
ACO Balcony drain with bell, H 120 – 220 mm					
	DN 50	6.0	120	0174.58.43	56.40
			140	0174.58.44	51.30
			160	0174.58.45	64.90
			180	0174.58.46	65.30
			200	0174.58.47	76.60
			220	0174.58.48	79.80
ACO Balcony drain with bell, H 120 – 240 mm					
	DN 70	5.5	120	0174.52.64	62.60
			140	0174.52.67	59.90
			160	0174.52.70	63.80
			180	0174.52.76	67.30
			200	0174.52.79	77.30
			220	0174.58.52	81.00
			240	0174.58.54	83.20
ACO Balcony drain with bell, H 120 – 220 mm					
	DN 100	7.0	120	0174.52.65	92.00
			140	0174.52.68	90.00
			160	0174.52.71	96.00
			180	0174.52.77	101.00
			200	0174.52.80	106.00
			220	0174.58.53	109.00
ACO Balcony drain with bell, H 300 mm					
	DN 50	6.0	300	0174.58.55	64.00
	DN 70	5.5		0174.58.56	76.00
	DN 100	7.0		0174.58.57	95.00
ACO balcony drain with side outlet, 1.5°					
	DN 50	2.4	98	0174.58.06	75.00
	DN 70	4.0	118	0174.58.07	95.00

*with sieve, for 35 mm accumulation height

ACO Balcony drains - with compression seal



Suitable for balconies with waterproofing membrane or reverse roofs.
Combined with the bottom part: for balconies with waterproofing membrane and

Product information

- can be used as single or direct drain
- can be used for various covering surfaces
- Bottom part for floor structure with thermal insulation
- made of corrosion-resistant stainless steel 1.4301
- small core drillings Ø: DN 50 / DN 70 with 130 mm, DN 100 with 150 mm



Balcony drain with compression seal flange for installation in a balcony slab with waterproofing membrane and additional covering surface

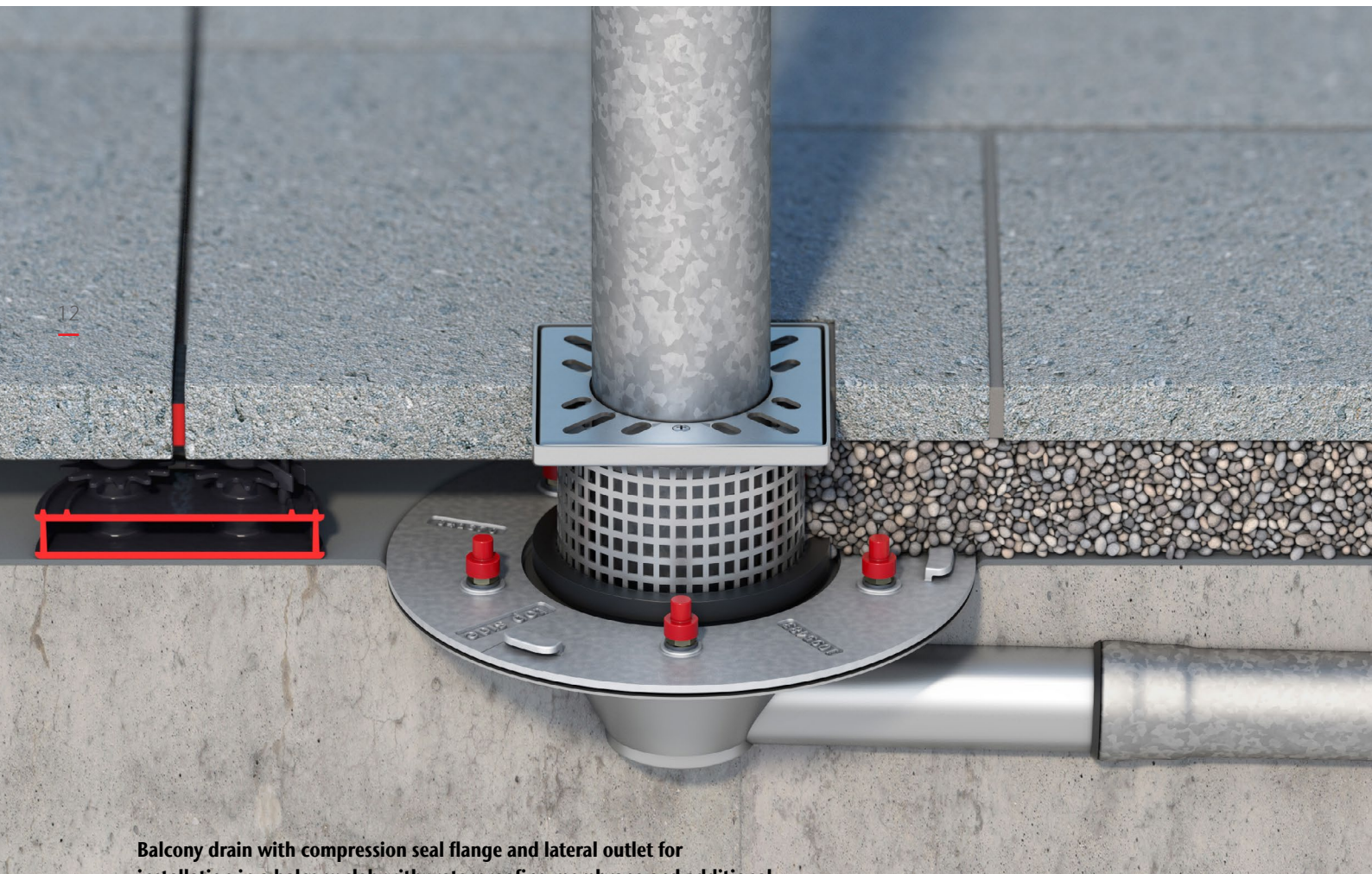

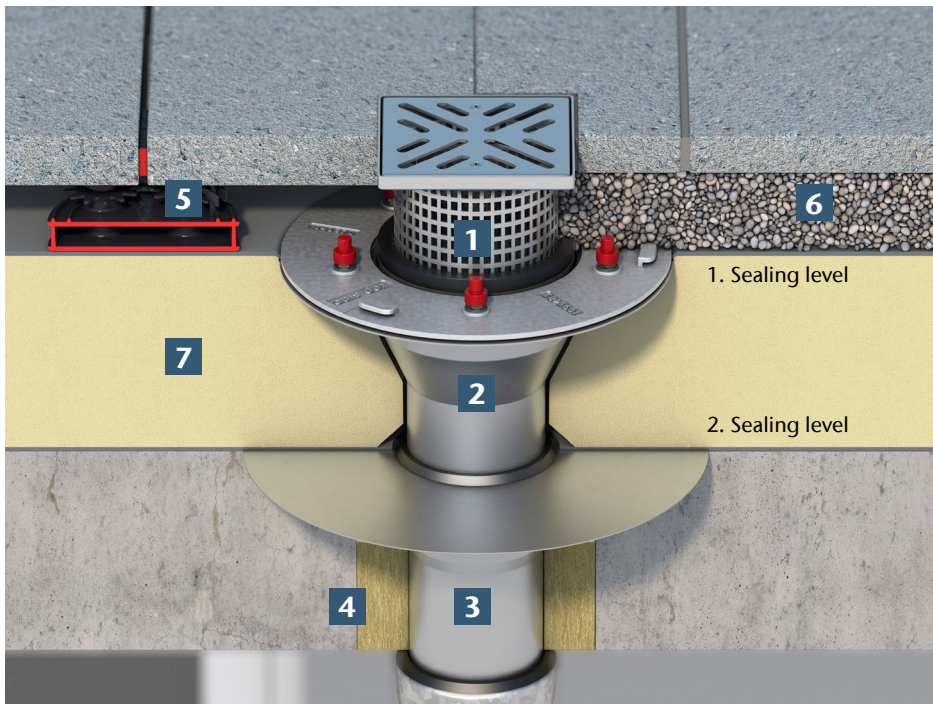

Balcony drain with compression seal flange and lateral outlet for installation in a balcony slab with waterproofing membrane and additional covering surface



- 1** Grating with sieve grating holder
- 2** Balcony drain with compression seal flange
- 3** Bottom section
- 4** Insulation casing
- 5** Version with elevated slabs
- 6** Version with gravel fill and slabs
- 7** Thermal insulation

Balcony drain combination for multi-part floor construction with thermal insulation

Ordering information

	Nominal diameter	Discharge capacity	Height	Article No.	Gross prices
		[l/s]	[mm]		[€]
ACO Balcony drain with compression seal flange					
	DN 50	5.0	200	0174.58.75	115.00
	DN 70	5.5		0174.58.76	120.00
	DN 100	7.0		0174.58.77	135.00
ACO Balcony drain with compression seal flange and side outlet					
	DN 50	2.4	94	0174.58.78	140.00
	DN 70			0174.58.79	150.00

*with top frame and grating, for 35 mm accumulation height

ACO Balcony drains - with adhesive flange



Suitable for balconies with liquid plastics or bituminous waterproofing membranes

Product information

- can be used as single or direct drain
- Can be used for various covering surfaces - regardless of the waterproofing layer
- made of corrosion-resistant stainless steel 1.4301
- small core drillings Ø: DN 50 / DN 70 with 130 mm, DN 100 with 150 mm





Balcony drain with adhesive flange for directly accessible waterproofing



Balcony drain with adhesive flange for installation in a balcony slab with liquid plastic waterproofing and additional covering surface

Ordering information

	Nominal diameter	Discharge capacity [l/s]	Height [mm]	Article No.	Gross prices [€]
ACO Balcony drain with adhesive flange					
	DN 50	6.0	200	0174.58.00	76.60
	DN 70	5.5		0174.58.01	88.70
	DN 100	7.0		0174.58.02	103.00
ACO balcony drain with adhesive flange and bell					
	DN 50	6.0	120	0174.58.10	84.20
			140	0174.58.11	85.30
			160	0174.58.12	87.50
			180	0174.58.13	89.60
			200	0174.58.14	91.90
			220	0174.58.15	96.80
	DN 70	5.5	300	0174.58.17	98.00
			120	0174.58.20	93.00
			140	0174.58.21	95.30
			160	0174.58.22	96.90
			180	0174.58.23	100.00
			200	0174.58.24	103.00
	DN 100	7.0	220	0174.58.25	106.00
			300	0174.58.27	112.00
			120	0174.58.30	116.00
			140	0174.58.31	119.00
			160	0174.58.32	121.00
			180	0174.58.33	123.00
			200	0174.58.34	126.00
			220	0174.58.35	131.00
			300	0174.58.37	137.00
ACO Balcony drain with adhesive flange and side outlet, 1.5°					
	DN 50	2.4	95	0174.58.03	109.00
	DN 70	4.0	115	0174.58.04	145.00

*with sieve, for 35 mm accumulation height

ACO Balcony drains - with flange



Suitable for balconies with liquid plastics or bituminous waterproofing membranes

Product information



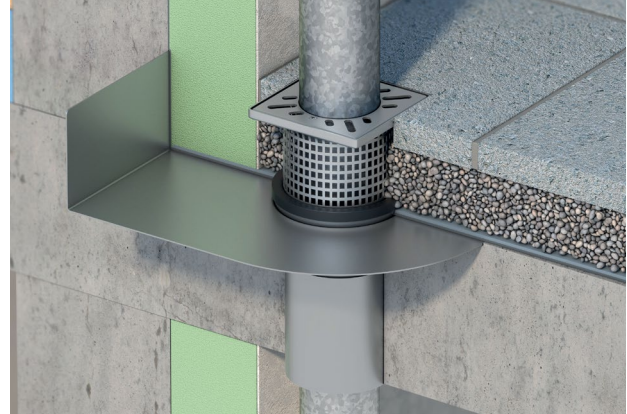

- with wall or corner wall flange
- Minimum distance of 30 mm to the wall possible, distance to the wall can be adjusted as required
- can be used as single or direct drain
- Can be used for various covering surfaces - regardless of the waterproofing layer
- made of corrosion-resistant stainless steel 1.4301
- small core drillings Ø: DN 50 / DN 70 with 130 mm, DN 100 with 150 mm



Balcony drain with wall flange for installation in a balcony slab with liquid plastic waterproofing and additional covering surface in the composite thermal insulation system

Balcony drain with corner wall flange for installation in a balcony slab with liquid plastic waterproofing and elevated terrace decking in a composite thermal insulation system

Ordering information

	Nominal diameter	Discharge capacity	Height	Wall distance/ Corner wall distance	Article No.	Gross prices
		[l/s]	[mm]	[mm]		[€]
ACO balcony drain with wall flange and adhesive flange						
	DN 50	6.0	200	30	0174.58.80	121.00
	DN 70	5.5			0174.58.81	131.00
	DN 100	7.0			0174.58.82	141.00
ACO balcony drain with wall flange, adhesive flange and bell						
	DN 50	6.0	200	30	0174.58.83	140.00
	DN 70	5.5			0174.58.84	153.00
	DN 100	7.0			0174.58.85	175.00
ACO balcony drain with corner wall flange and adhesive flange						
	DN 50	6.0	200	30	0174.58.90	141.00
	DN 70	5.5			0174.58.91	154.00
	DN 100	7.0			0174.58.92	164.00
ACO balcony drain with corner wall flange, adhesive flange and bell						
	DN 50	6.0	200	30	0174.58.93	157.00
	DN 70	5.5			0174.58.94	168.00
	DN 100	7.0			0174.58.95	185.00







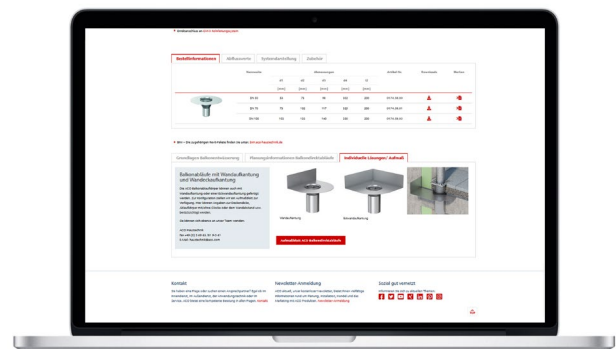









Measurement sheet for variable wall spacing

The wall clearances and construction heights required for the building project can be entered into the ACO measurement sheet <http://aco.me/aufmassbalkonablauf>.

Please send the completed measurement sheet to the following email address: haustechnik@aco.com



Ordering information for accessories

	Designation	Nominal diameter	Article No.	Gross prices
		[mm]		
	PE ACO grating holder with retaining ring	DN 50	0174.58.61	19.90
		DN 70		
		DN 100	0174.58.71	26.00
	Stainless steel ACO grating holder with retaining ring	DN 50	0174.58.62	45.30
		DN 70		
		DN 100	0174.58.72	58.30
	Stainless steel ACO sieve grating holder with retaining ring	DN 50	0174.58.63	56.50
		DN 70		
		DN 100	0174.58.73	66.40
	ACO strainer pipe	DN 50	0174.58.64	72.70
		DN 70		
		DN 100	0174.58.74	77.40
	sieve	DN 50	0174.96.82	6.40
		DN 70	0174.52.49	11.50
		DN 100		
	Ring sieve	DN 50	0174.58.65	6.40
	Ring sieve	DN 70	0174.52.56	7.60
	Ring sieve	DN 100	0174.52.57	11.50
	Gratings	DN 50	0174.52.58	14.70
		DN 70		
		DN 100	0174.52.59	18.70
	Gratings	DN 50	0174.58.66	13.90
	Gratings	DN 70	0174.52.60	15.30
	Gratings	DN 100	0174.52.61	18.70
	Bottom part of the balcony drain	DN 50	0174.58.86	60.00
		DN 70	0174.58.87	70.00
		DN 100	0174.58.88	90.00
	Insulating sleeve for lower part of balcony drain	DN 50	0174.59.09	90.00
		DN 70	0174.59.10	97.00
		DN 100	0174.59.11	97.00



ACO Spout

If perimeter balcony parapets are preventing drainage over the edges, two independently operating drainage systems should be installed - for example, a balcony drain and a spout for emergency drainage. Alternatively, the spout can also be used as the main drainage system by installing it flush with the balcony slab. Depending on the installation situation, the flange of the spout is bent to the required height on site.

Product information

- Spouts for emergency and main drainage
- suitable for bending the flange on site
- Drainage into the open or via downpipe
- suitable for liquid plastics and bituminous waterproofing membranes

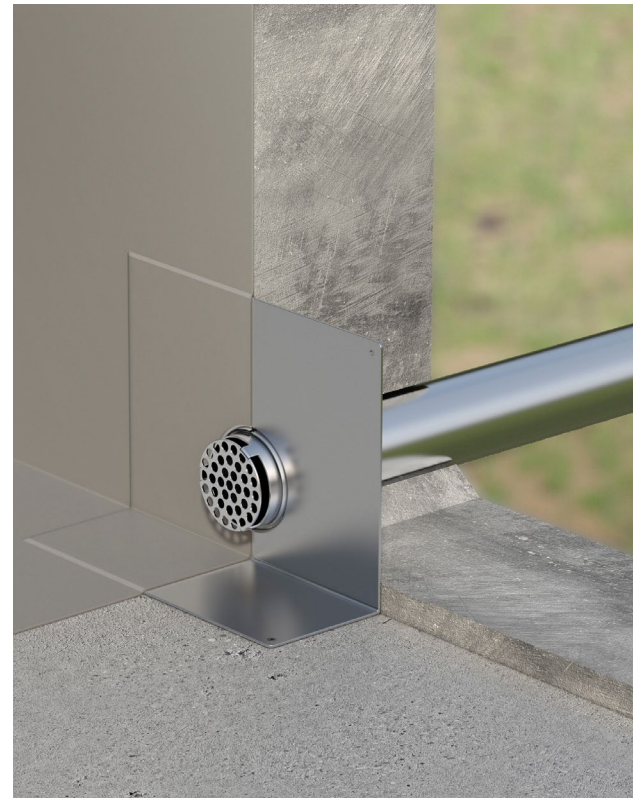

ACO spout for emergency drainage - sealed with liquid plastic

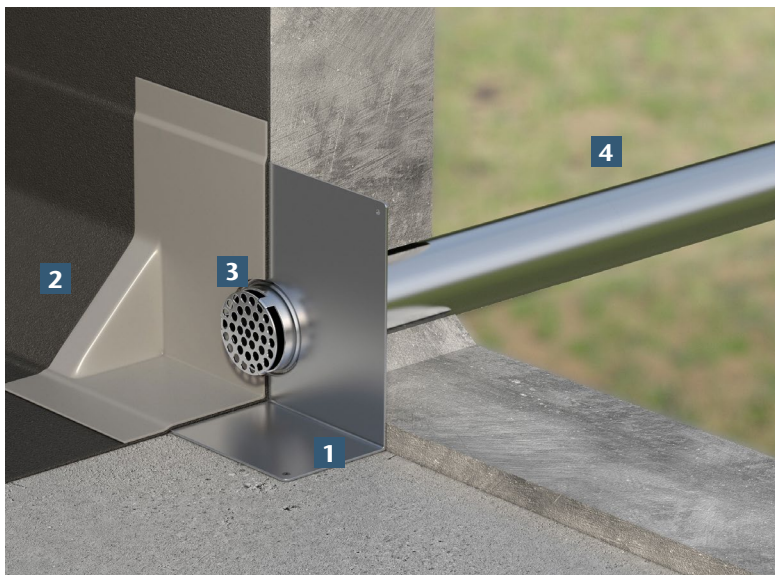

- 1 on-site folding of the flange
- 2 bituminous waterproofing membrane on wedge
- 3 Connection of ACO spout with liquid plastic
- 4 Drainage into the open or alternatively connected to a downpipe

ACO spout for emergency drainage - sealed with bituminous waterproofing membrane on connection wedge and liquid plastic in the area of the spout



ACO spout for main drainage - flush with the balcony slab, sealed with liquid plastic sealant.

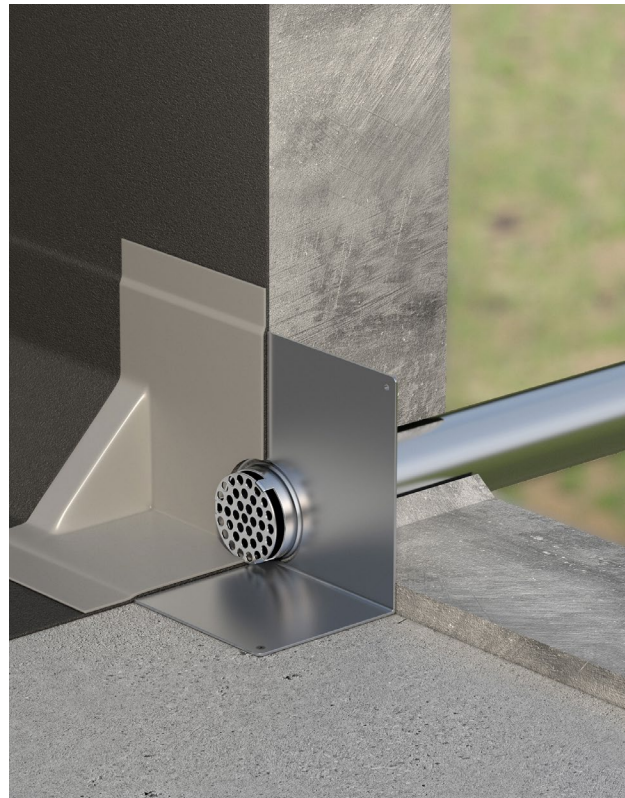



ACO spout for main drainage - flush with the balcony slab, sealed with bituminous waterproofing membrane and liquid plastic in the area of the spout.

Ordering information

	Nominal diameter	Discharge capacity		Length	Article No.	Gross prices
		Drainage into the open	Drainage with attached GM-X pipe unit			
		[l/s]		[mm]		[€]
ACO spout for bending on site						
	DN 50	0.4	0.5	800	0174.58.97	74.00
	DN 70	0.6	0.7		0174.58.98	85.00
	DN 100	0.7	0.8		0174.58.99	115.00

*with grating for spout, at 35 mm accumulation height

Accessories

	Nominal diameter	Designation	Article No.	Gross prices
				[€]
Gratings for spout				
	DN 50	Grating for spout	0174.59.00	25.00
	DN 70		0174.59.01	43.00
	DN 100		0174.59.02	60.00
	DN 50	Grating for spout for emergency drainage	0174.59.03	25.00
	DN 70		0174.59.04	40.00
	DN 100		0174.59.05	56.00

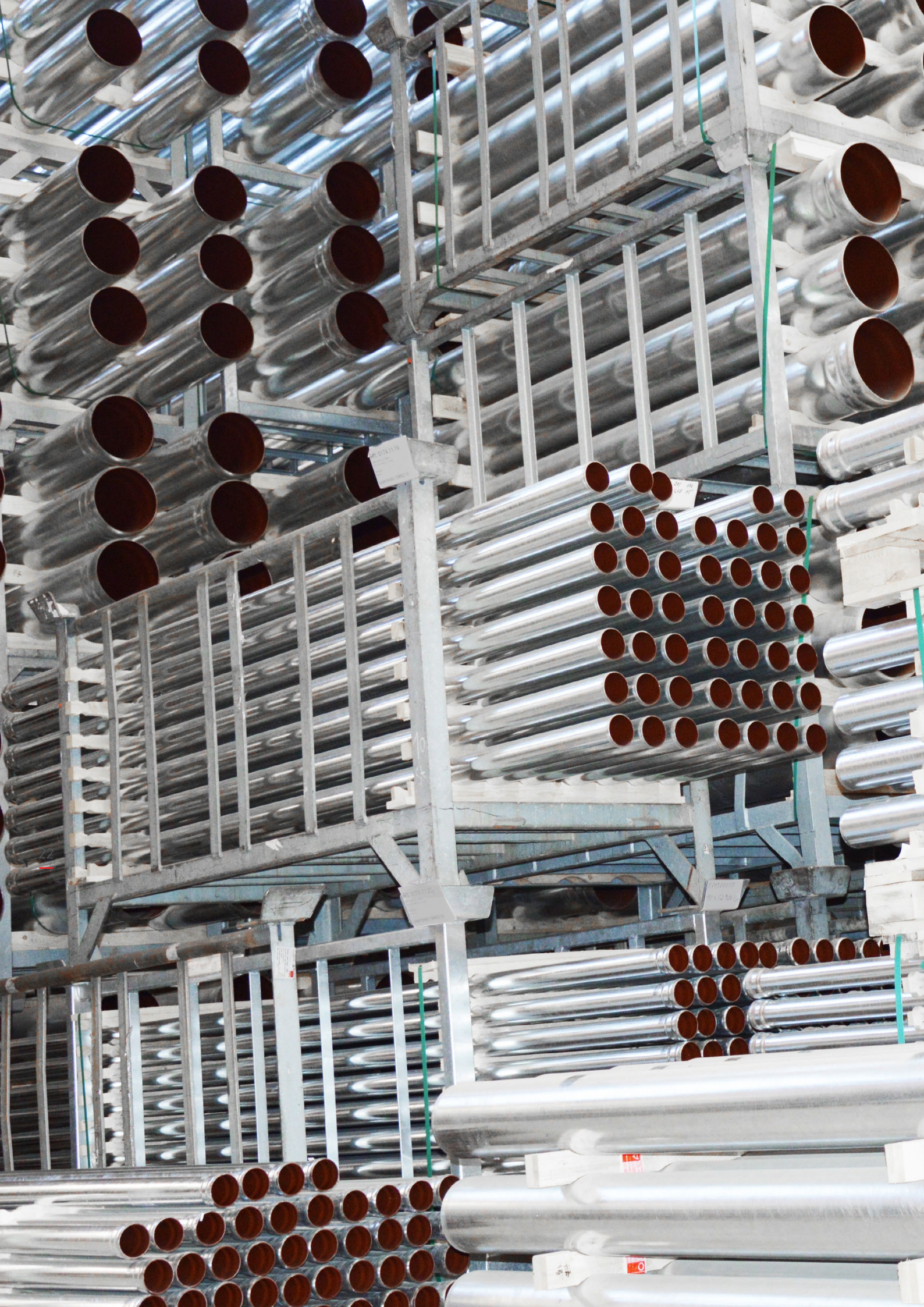



GM-X steel drainpipes

The use of the highly stable GM-X pipe system is the cornerstone of safe rainwater drainage in all aspects of building drainage from balconies and roof areas. In order to meet the requirements of building planning law, ACO Building Drainage offers a complete GM-X range of drainage pipes and fittings made of galvanized steel. The large selection of fittings and connections enable the GM-X pipe system to be professionally and quickly installed on balcony drains or the spout.

Product information

- galvanized steel drainage pipe system
- DN 32 – DN 300
- Sound insulation tested according to DIN 4109 and VDI 4100
- highly stable, durable material
- Conforms to DIN EN 1123
- Building material class A1, non-combustible according to DIN 4102 and DIN EN 13501

Each ACO Building Material product supports the ACO system chain



- Floor drainage
- Bath drainage
- Roof drainage
- Multi-storey car park drainage
- Balcony and terrace drainage
- Pipe systems
- Grease separator
- Starch separators
- Light liquid separator
- Process engineering
- Backflow systems
- Lifting Plants

ACO Haustechnik

ACO Passavant GmbH
Im Gewerbepark 11c
36466 Dermbach
Tel. 036965 819-0
Fax 036965 819-361

haustechnik@aco.com
www.aco-haustechnik.de

**ACO. Creating
the future of drainage**

