

PREVENTATIVE FIRE PROTECTION

Preventative fire protection and its implications for the technical aspects of a building continue to be a hot topic which places high fire protection specifications on all of the trades involved in the construction industry, and involves significant liability risks. **Due to differing regulations in Europe, a cross-national overview is not possible. Therefore we will focus on German restrictions and regulations. Country-specific standards have to be considered.** The main causes for complaints during the inspection of new buildings and serious fire damage are ineffective preventative measures and fire barriers. The new building planning law based on MBO 2002 therefore focuses in its special installation section on customised fire protection concepts specifically designed for each building. Once MBO 2002 forms the basis for planning regulations in each of the German states, a large part of the responsibility for fire protection equipment and technical aspects will fall on the designers of the concepts (fire protection experts), architects, construction supervisors, technical planners and the builders.

A simplified authorisation procedure applies in some federal German states for building classes 1 to 3. In these cases, the architect, as the designer of the building, bears complete responsibility for the elaboration of the concept, as well as for preventative fire protection and its implementation. In the case of building classes 4 and 5, most federal German states stipulate a fire protection concept analogous to those for special buildings. The construction supervisor is held responsible by the Building Supervisory Authority for the implementation by all of the trades of all of the technical fire protection aspects in all building classes and special buildings. If the construction supervisor lacks the appropriate technical expertise for any of the trades, state planning regulations require the construction supervisor to engage additional construction supervisors with the appropriate knowledge. The greatest risk when a fire breaks out is usually the propagation of the fire through the Building Services equipment and installations. This is particularly true if unsuitable products have been selected by unprofessional planning, and if gaps around construction components have not been properly sealed in accordance with the specified fire resistance classes.

1. Principles behind preventative fire protection

Preventative fire protection in buildings is designed to safely prevent the propagation of fire and smoke between the separate fire zones in a building. The targets for preventative fire protection defined in construction law, include the following stipulations and regulations:

- Model Planning Regulations (MBO)
- State Building Regulations (LBO)
- Special Planning Regulations (SBO)
- Adopted Technical Regulations (ETB)
- DIN 4102-4 Fire properties of construction materials and construction components
- Pipe and Cable System Regulations (LAR/RbALei)
- DIN 4109/A1 Noise protection

1.1 Specifications pursuant to the Model Planning Regulations

The main protection objectives laid down in the Model Planning Regulations 2002 are regulated in § 3 and § 14.

§ 3 General Specifications

- (1) Installations must be laid out, installed, modified and maintained to ensure that it represents no hazard to public safety and order: in particular to life, health and natural life support systems.
- (2) Construction products and construction types are only authorised for use when they enable the installations in the building in which they are installed to fulfil the specifications of this law or specifications based on this law for an appropriate time period with regard to their purpose when the installations are properly maintained, and when the installations and equipment are suitable for their proposed application.

§ 14 Fire Protection

Installations in buildings must be laid, installed, modified and maintained so that it prevents the establishment of a fire, and the spread of fire and smoke (fire spreading), and in the event of a fire does not hinder the rescue of people and animals, and assists the implementation of effective fire extinguishing measures.

The specifications pursuant to the Model Planning Regulations (MBO 2002) are shown in Table 1 with respect to building drainage, i.e. for ceiling and wall openings, floor and roof drains and pipes.

- ¹⁾ Pursuant to § 40 and § 41, no specifications are laid down for fire barriers for pipe and cable systems, installation shafts, ducts and pipe and cable systems within residential buildings and utility units with less than 400 m² and not more than two storeys.
- ²⁾ No specifications are defined for the ceilings below attic rooms and flat roofs if the attics contain no living spaces.
- ³⁾ Different specifications apply to special buildings. Details are defined in the Special Planning Regulations and the Special Fire Protection Concept incorporated in the building regulations.
- ^{A)} F30 specifications apply to load bearing building components in cellars in Bavaria, Hessen and Hamburg. Fire barriers around cables and pipes in F30 construction components with specifications regarding fire, noise and thermal protection.
- ^{B)} Fire barriers for F60 construction components are not available on the market at the moment. Fire barriers for F90 construction components should therefore be installed as an alternative.
- ^{C)} In those German states in which F-30 specifications do not apply (as at 01/2006: North Rhine-Westphalia, Schleswig Holstein, Bremen, Mecklenburg-Vorpommern, Niedersachsen, Baden-Württemberg) there is no legal requirement to install fire barriers alongside F30 construction components. However, use of fire barriers is recommended in all cases in order to fulfil the protection objectives of the recognised technical guidelines.























Building features	Component	1 and 2
Height difference between upper edge of soil and upper edge of floor of living space highest situated		≤ 7 metres
Number of residential buildings/utility units		≤ 2
Residential/utility area		Total area ≤ 400 m ²
Cellar storey ceilings MBO § 31 (2)		no requirement for fire barriers of pipes ¹⁾ component F 30
Upper storey ceilings MBO § 31 (1)		no requirement for fire barriers of pipes ¹⁾ component F 30
Room isolating partition walls in upper storeys MBO § 29		F 30 ^{C)}
Walls of floors and exits required for access to the open air MBO § 35 (4)		no requirement for fire barriers of pipes ¹⁾ component F 30
Walls of necessary stair rooms MBO § 35 (4)		no requirement for fire barriers of pipes ¹⁾ component F 30 ^{A)}
Building partition walls, fire walls		no requirement for fire barriers of pipes ¹⁾ component F 30

Table 1: Classification of components to be protected

Building class			
	4	5	Special buildings
≤ 7 metres	≤ 13 Meter	≤ 22 metres	≥ 22 metres
> 2	each number	each number	each number
see building regulation	see building regulation	see building regulation	see relevant special building regulation
			
F 90 ^{A)}	F 90	F 90	F 90/F 120 ³⁾
			
F 30 ^{2) C)}	F 60/F 90 ^{2) B)}	F 90 ²⁾	F 90/F 120 ^{2) 3)}
			
F 30 ^{C)}	F 60/F 90 ^{B)}	F 90	F 90 ³⁾
Upper storeys F 30 	Upper storeys F 30 	Upper storeys F 30 	Upper storeys F 30 
Lower storeys F 90	Lower storeys F 90	Lower storeys F 90	Lower storeys F 90
			
F 90 ^{A)}	F 90 ^{A)}	F 90 ^{A)}	F 90 ^{A) 3)}
			
F 60/ F 90 ^{A) B)}	F 60/ F 90 ^{A) B)}	F 90 ^{A)}	F 90 ^{A) 3)}

1.2 Specifications defined in State Building Regulations

The State Building Regulations stipulate the use of fire barrier measures when pipes or floor drains are installed in ceilings and walls which correspond to specific fire resistance classes.

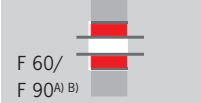
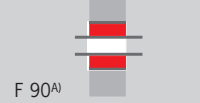
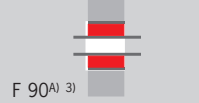
This applies to the following fire resistance classes

- fire retardant (F30)
- extremely fire retardant (F60)
- fire resistant (F90)
- extremely fire resistant (F120)

In the following German states, it is only possible to dispense with the installation of classified fire barrier components for F30 and F60 construction components, when making allowance for the fire protection specifications until the Model Planning Regulations 2002 are legally implemented in the Building Regulations of each state:

- Schleswig Holstein
- Mecklenburg-Vorpommern
- Niedersachsen
- Bremen
- North Rhine-Westphalia
- Baden-Württemberg

1.3 Specifications pursuant to Special Planning Regulations

The technical fire protection specifications defined for buildings of either special type or scheduled for special use – such as industrial buildings, retail outlets, places of assembly, hospitals, schools, hotels etc. – are governed by regulations including the following special Building Regulations:

- Regulations for Structural Fire Protection in Industrial Buildings
- Retail Outlet Regulations
- Regulations Covering Places of Assembly
- Hospital Building Regulations
- Garage Building Regulations
- Multi-storey Building Regulations
- School Building Regulations

The regulations for pipe and cable systems (LAR) applying to the installation of fire barrier components in special buildings in accordance with building regulations are specified in Chapter 4.

Any specifications exceeding these regulations can be regulated in a project-specific fire protection concept.

We recommend that the specific codes applying to each German state are downloaded, e.g. the special Building Regulations etc. These can be downloaded from the following websites:

- www.mlpartner.de
- www.is-argebau.de
- [www.\(name of the German state\).de](http://www.(name of the German state).de)

1.4 Specifications pursuant to the Pipe and Cable System Regulations

The Pipe and Cable System Regulations incorporated in Chapter 4 of Building Regulations define the specifications stipulated for quality of pipe and cable ducts/fire barrier components.

1.5 Specifications for floor, roof and multi-storey car park drains

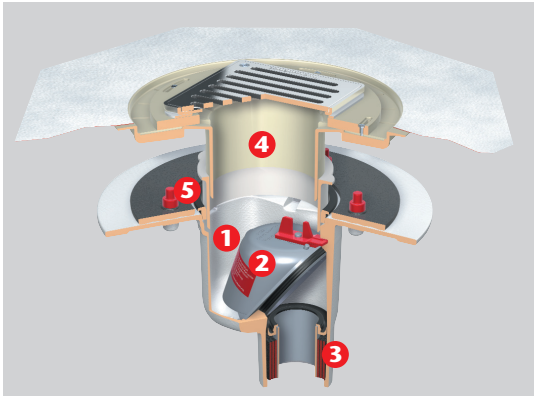

- 1 ACO WAL-SELECTA fire protection floor drain DN 70
- 2 ALL PURPOSE odour seal with heat shield
- 3 Fire protection cartridge with intumescence mass
- 4 AV-SELECTA, PP top section
- 5 Sealing ring

Floor, roof and multi-storey car park drains are located at the front end of a drainage system and are classified as an integral part of drainage systems pursuant to DIN EN 12056/DIN 1986-100. These components therefore have to comply with the specifications defined by the Pipe and Cable System Regulations.

The Pipe and Cable System Regulations differentiate here between two fire barrier principles:

- classified fire barrier components in R 30 to R 120 quality

Fire certification based on DIN 4102-11 is demanded in all cases from an accredited state-certified material testing institute. Suitability certification is issued by way of a General Building Supervisory Authority Authorisation (ABZ) or a General Building Supervisory Authority Test Certificate (ABP). The fire certification certifies resistance to a maximum permissible surface temperature increase averaging 140 K (Kelvin), and a point surface temperature increase at one point of 180 K on the side opposite the fire. These limits reliably prevent secondary fires breaking out during a fire.

By using specified fire barrier components for fire resistance classes R 30 to R 120, the specialist planners can avoid the need to determine other measures in the building if the relevant authorisations and test certificates are available. This means planning reliability, particularly at the interfaces between fire barrier components and the building structure.

The floor, roof and multi-storey car park drains manufactured by ACO Haustechnik in inflammable cast iron and stainless steel successfully passed the standard fire tests for classifications R 30 to R 120. Effective fire and smoke seals were also certified for the floor drains to prevent fire spreading downwards (see 6.1).

– Ducts pursuant to the dispensations in MLAR/LAR/RbALei.

This does not take into consideration the increase in temperature on the side facing the fire. This means that the technical planner has to undertake measures within the building based on average temperature increases (greater than 140 K) to prevent the creation of secondary fires.

This requires very detailed tender documentation.

The dispensations do not permit the connection of flammable drain pipes to floor, roof and multi-storey car park drains. When inflammable drainage pipes are connected, continuous isolation of the room must be guaranteed from the buried pipe to the downpipe and the connection to the drain. Fastenings and connections must consist of inflammable materials, e.g. M8 steel plugs, plus threaded rod, plus friction connections (rapid connectors or similar).

Using ACO Haustechnik fire protection floor, flat roof and multi-storey car park drains avoids the application of the dispensations and the associated extra work and expense. The fire protection function of cast iron and stainless steel floor drains in the WAL-SELECTA and VARIANT-CR drain product lines have already been certified in fire tests for fire resistance classes R 30 to R 120. The vertical fire protection floor drains have General Building Supervisory Authority Authorisation (ABZ Number Z-19.17-1527) and the horizontal fire protection floor drains have General Building Supervisory Authority Test Certificates (ABP Number P-MPA-E-02-005). Certification from DIBt Berlin has been applied for for the floor and multi-storey car park drains.

1.6 Specifications for drain pipes

The specifications defined in the Pipe and Cable System Regulations must be complied with by flammable and inflammable drainage pipes.

The Pipe and Cable System Regulations also differentiate between two fire barrier principles for drainage pipes:

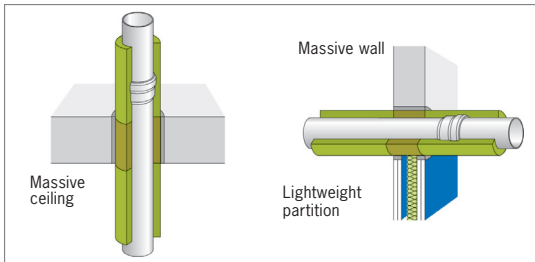

R 30 to R 90 pipe fire barriers for ACO GM-X steel drain pipe pursuant to DIN EN 1123 with Rockwool Conlit fire barrier systems

- Classified fire barriers in R 30 to R 120 quality

Fire certification based on DIN 4102-11 is demanded in all cases from an accredited state-certified material testing institute.

Suitability certification is issued by way of a General Building Supervisory Authority Authorisation (ABZ) or a General Building Supervisory Authority Test Certificate (ABP). The fire certification certifies resistance to a maximum permissible surface temperature increase averaging 140 K as the temperature increase. These limits reliably prevent secondary fires breaking out during a fire.

By using specified fire barrier components for fire resistance classes R 30 to R 120, the specialist planners can avoid the need to determine other measures in the building if the relevant authorisations and test certificates are available. This means planning reliability, particularly at the interfaces between fire barrier components and the building structure.

ACO GM-X steel drain pipes pursuant to DIN EN 1123 can be properly insulated using RS 800 insulating collars for F 30 ceilings and walls to create fire barriers compliant with fire resistant classes R 30 to R 90. The combination of RS 800 insulating collars with Conlit collars is required for F 60 and F 90 ceilings and walls. Application certification is confirmed by ABP Number P-3725/4130-MPA BS issued on behalf of Rockwool.

- Ducts pursuant to dispensations in MLAR/LAR/RbALei

Flammable drainage pipes $d > 32\text{mm}$ are not permissible according to the dispensations. The temperature on the side of the component facing the fire is not taken into consideration in inflammable drainage pipes. This means that one can only guess whether there is actual compliance with the specification in DIN 4102-11 that the max average surface temperature increase is 140 K (or 180 K at one point) on the side of the drainage pipe facing away from the fire. As a result, the technical planner has to make special plans for additional insulation or use special system solutions from manufacturers to prevent secondary fires which could be generated if the permissible surface temperature is exceeded. This requires very detailed tender documentation. When inflammable drainage pipes are connected, continuous isolation of the room must be guaranteed from the buried pipe to the downpipe and to the connection to the drain. Fastenings and connections must consist of inflammable materials, e.g. M8 steel plugs, plus threaded rod, plus push connections.

ACO GM-X steel drain pipes can be installed even pursuant to the dispensations in MLAR/LAR/ RbALei. In this case, the technical planner has to observe the conditions existing in the building to prevent secondary fires.

ACO GM-X compound pipes are insulated to form effective fire barriers by using ACO GM-X fire protection mouldings in massive ceilings, massive walls and lightweight partition walls specified for fire resistance class F 30 to F 90 (see 6.6). The application certification is undertaken pursuant to the dispensations in MLAR/ RbALei.

2 Application certification/compliance declarations/markings

Fire protection floor drains and pipe fire barriers using intumescent masses installed in ceilings and walls with fire resistance classes F 30 to F 120, can only be used if they have General Building Supervisory Authority Authorisation. This authorisation specifies the fire resistance classes for which the floor drains are certified, and the conditions under which these components can be used. The General Construction Supervisory Authority Authorisation is only issued when the product has passed a fire test conducted by a certified testing agency.

The following table highlights the application certifications, compliance declarations and marking required.

Ducts pursuant to	Application certification	Type plate required	Compliance declaration required (sample see ABP/ABZ)	ABP/ABZ
LAR Chapter 4.1	ABZ	yes	yes	Per installed system
	ABP	no	yes	Per installed system
LAR Chapter 4.2	Application certification is pursuant to dispensations in LAR/RbALei	no	no	Copy of the building regulations in LAR/RbALei if required

Conditions to be complied with by duct solutions

ACO Haustechnik fire protection floor drains with General Construction Supervisory Authority Authorisation ABZ Number Z-19.17-1527 are supplied with installation instructions which include a compliance declaration and a red type plate (see picture below).

The relevant compliance declaration must be submitted by the installation company for every installed fire protection drain type (see figure below left).

The type plate supplied (figure below right) must be fixed in place next to each fire barrier.

Übereinstimmungsbestätigung

Name und Anschrift des Unternehmens, das die Rohrabschottung hergestellt hat _____

Baustelle/Gebäude _____

Datum der Herstellung _____

Feuerwiderstandsklasse der Rohrabschottung _____

Hiermit bestätige ich, dass

- die Rohrabschottung System ACO-Passavant WAL[®], /VARIANT[®] SELECTA (Susselien)/VARIANT[®] CR (Edelstahl) Brandschutz-Bodenabläufe mit Geruchsverschluss, senkrecht (90°) zum Einbau in Decken der Feuerwiderstandsklasse R 90 bis R 120 hinsichtlich aller Einzelheiten fachgerecht und unter Einhaltung aller Bestimmungen der allgemeinen bauaufsichtlichen Zulassung Nr. Z-19.17-1527 des Deutschen Instituts für Bautechnik vom 2. Juli 2003 hergestellt und eingebaut wurden und
- die für die Herstellung des Zulassungsgegenstandes verwendeten Bauprodukte (z. B. Rohrmanschette bzw. Einbausetz, Brandschutzzeigle u. a.) entsprechend den Bestimmungen der allgemeinen bauaufsichtlichen Zulassung gekennzeichnet waren.

(Ort/Datum) _____ (Stempel/Unterschrift) _____

Diese Bescheinigung ist dem Bauherrn zur ggf. erforderlichen Weitergabe an die zuständige Bauaufsichtsbehörde beizufügen!

Compliance declaration example

Rohrabschottung

**Brandschutz-Bodenablauf
SELECTA/VARIANT-CR
Feuerwiderstandsklasse
R 120, R 90 bzw. R 30
Zulassungs-Nr. Z-19.17-1527**

**ACO Haustechnik
ACO Passavant GmbH
D-36269 Philippsthal
Herstellungsjahr:
2005 ■, 2006 ■, 2007 ■,
2008 ■, 2009 ■**

**Einbau gem. den Übereinstimmungs-
nachweisen der einbau-
enden Firma.**

Unterschrift _____

Example of a type plate for fire barriers

3. Preventing fires spreading from below and/or from above

DIN 4102-11: 1985-12, Para. 4.2.1 stipulates:

"Fire barriers around pipes installed in ceilings are always more seriously affected by fires coming from below the ceiling. If in doubt, investigations should also be carried out to test the effect of flames coming from above."

DIN EN 1366-3: 2004-11, Para. 6.3 regulates certification with respect to the effect of fires on the product when the fire is beneath the ceiling.

Footnote ¹⁾ also stipulates:

"The effects of fires coming from beneath ceilings is generally more critical than the effect of fires affecting the top of a ceiling. In addition to the specifications for classifying the effect of fires acting on the base of the ceiling, specifications may also be stipulated regarding the thickness and quality of floor coverings/ceilings, and the associated design to protect against fires affecting the top of the ceiling."

This specification can also affect floor drains if this is specifically required by the project-specific fire protection concept. ACO Haustechnik floor drains made of cast iron and stainless steel with odour seals have already been tested and certified for their fire resistance from above and below in standard fire tests pursuant to DIN 4102-11, Para. 4.2.1 and DIN EN 1366-3, Para. 6.3. Using products with fire resistance application certificates for above-ceiling and below-ceiling fires enhance the planning and execution security for building managers, technical planners and contractors.

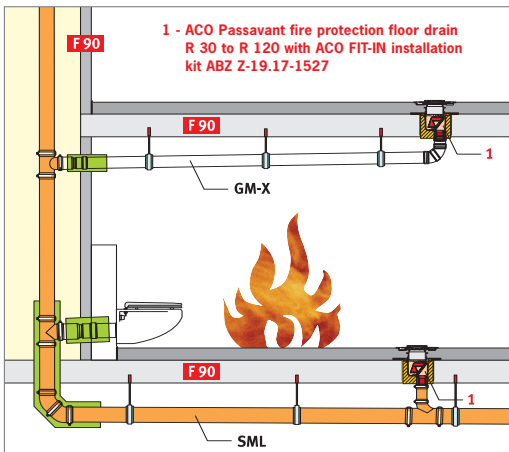

Effective fire barrier using ACO Haustechnik fire protection floor drains (1) prevents fire spreading upwards and downwards.

4 Planning for preventative fire protection

In terms of building regulations, drainage systems in buildings are designated as open systems. The isolation of open systems with effective fire barriers is guaranteed in accordance with the Pipe and Cable System Regulations (MLAR/LAR/RbALei) when rooms can be reliably sealed off and isolated in the event of a fire. Planning has to observe the building regulation specifications, the protection targets of the LBO, general specifications (§ 3, MBO), traffic safety regulations concerning exit and rescue routes, and blocking and preventing the spread of fire and smoke (§ 14 MBO). In addition to these, the protection specifications of MLAR/LAR/RbALei (Chapter 3 Emergency Exit Routes, and Chapter 4 Ducts/Fire Barriers) must also be observed.

Execution planning usually complies with the principles laid down in the General Technical Contractual Conditions (ATV) of VOB-C: DIN 18381: 2002-12. The DIN regulates that all measures for fire and noise protection, including the necessary condensation water insulation, be planned and tendered as special services.

ACO's technical data sheets and documentation include relevant notes on execution planning, tendering and the technical aspects of fire barriers for fire protection.

4.1 Room isolation when dealing with inflammable drainage pipes

is only achieved by the interaction of the pipe material, classified R 30 to R 120 fire barriers, friction connectors (e.g. rapid or similar) and the proper inflammable fastenings.

4.2 Room isolation when dealing with flammable drainage pipes

is achieved with R 30 to R 90 fire protection sleeves which seal off the cross-section of the piping at temperatures of approx. 150°C, with burning of the pipe up to the fire barrier.

4.3 Room isolation when dealing with fire protection floor drains with odour seal

Unlike piping which runs continuously through various storey ceilings, the floor drain is the open end of a pipe system.

If storey ceilings are penetrated by floor drains with specified fire resistance classes e.g. F 30, F 60 or F 90, the appropriate fire and smoke stops must be used to guarantee the formation of a secure fire barrier in the ceiling. This requires the installation of fire protection floor drains of the appropriate fire resistance class, e.g. R 30, R 60 or R 90 (see Figure 1).

ACO Haustechnik WAL-SELECTA and VARIANT-CR series fire protection floor drains with vertical outlets are made of inflammable cast iron or stainless steel. They are therefore not an additional fire risk in a ceiling. These drains are sealed against fire and smoke by using replaceable and retrofittable fire protection kits. These fire protection floor drains comply with fire resistance classes R 30, R 60, R 90 and R 120.

4.4 Room isolation using fire protection roof drains without odour seals for syphonic drainage

Fire protection flat roof drains are required under certain conditions for flat roofs. This always applies when the separation between roof drains and a rising wall in such areas is less than 5m. If this applies, an appropriate fire protection roof drain without an odour seal must be installed. This ensures that fire and smoke cannot spread into the neighbouring part of the building.

Special attention must be paid here to the fire resistance class of the roof structure, e.g. F 30, F 60 or F 90. The roof drain has to have at least the same or a higher fire resistance class (R 30, R 60 or R90).

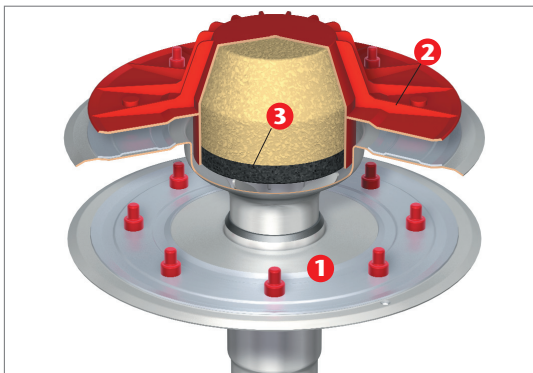

- 1 ACO JET fire protection flat roof drain for syphonic drainage
- 2 Red air lock with fire protection insert
- 3 Intumescent mass

- Preventing the spread of fires to the insulation lying on top of the ceiling as a result of temperature conduction through the walls or piping

The protection objectives are defined by Section 14 MBO "Fire Protection concerning the prevention of fires spreading via flames and smoke". The specifications for small ducts in DIN 18234 must be observed for large area roofs (exceeding 2000m²).

ACO Haustechnik JET (R 30 to R 90) fire protection drains can be connected to either flammable or inflammable drainage pipes. Fire and smoke cannot penetrate because of the installation of a special fire protection top section in roof drains used in syphonic drainage systems (see 6.4).

4.5 Room isolation using fire protection roof and multi-storey car park drains without odour seals for open-channel drainage

Small, medium sized and large garages have to be constructed in compliance with the garage regulations specified in the building laws in each of the federal German states. Multi-storey car park drains without odour seals are usually installed. Multi-storey car park fire protection drains without odour seals have to be installed in compliance with the fire resistance classes applying to enclosed garages with multi-storey parking decks. This is particularly important when using flammable connecting pipes.

ACO Haustechnik JET (R 30 to R 90) fire protection multi-storey car park drains can be connected to either flammable or inflammable drainage pipes. Fire and smoke cannot penetrate because of the installation of a special fire protection insert (see 6.3 and 6.4).

4.6 Fire protection for grey water pipes

When inflammable grey water pipes are ducted through room-sealing walls and ceilings with designated fire resistance classes (F 30 to F 120), compliance is required with the fire barrier specifications in accordance with the building regulations and specifically the Pipe and Cable System Regulations (LAR/RbALei), Chapter 4. These specifications can be implemented using either authorised fire barriers in R 30 to R 120 quality, or in accordance with the dispensations. The effective fire barrier ceiling options for ACO GM-X pipes are shown in Sections 6.5 and 6.6.

4.7 Fire protection involving rain water pipes

Rain water pipes usually differ from grey water pipes by the use of diffusion-barriers to prevent the formation of condensation water. The diffusion-barrier materials used in practice are:

- Artificial rubber, building material class B1/B2. Synthetic rubber must be used together with R 30 to R 120 classified pipe fire barriers e.g. Pyrostat UNI type RM, RMB or RM/LT.
- Aluminium-film-covered insulating sleeves made of mineral wool, melting point >1,000°C, building material class A2. This insulation can be used with either R-classified fire barriers or fire barriers in accordance with the dispensations making allowance for the separation regulations.
- Using pre-fabricated compound piping with integrated condensation water insulation, e.g. ACO GM-X compound piping.

ACO GM-X pipe can be used together with synthetic rubber and aluminium-film-coated mineral wool sleeves with the aforementioned fire barrier options (see 6.5 and 7.5).

Prefabricated ACO GM-X compound piping is built as standard with condensation water protection and protection to prevent damage to the insulation. The pipes can be used as a design feature and laid on top of walls without cladding. ACO GM-X fire protection mouldings (see 6.6 and 7.6) are used as fire barriers in walls and ceilings in compliance with the fire resistance classes.

5. Execution of the preventative fire protection in building drainage

The quality of the workmanship in executing preventative fire protection measures largely depends on the detailed planning and tendering. The general technical contractual conditions (ATB) of VOB-C defined by DIN 18381: 2002-12 "Gas, water and drainage systems within buildings" sets the standards for the recognised technical guidelines (see also 4).

The main contractual principles which apply are the separately agreed contractual conditions, the BGB regulations, or the VOB regulations. The recognised technical guidelines apply depending on the type of contractual conditions selected if no separate agreements have been reached which differ from these regulations. The specifications in the adopted technical building regulations must be complied with as the minimum public law specifications.

Complying with preventative fire protection measures for pipe systems is regulated in accordance with the technical building regulations laid down in the Pipe and Cable System Regulations (MLAR/LAR/RbALei). The recognised technical guidelines are regulated in addition to the above by VOB-C, DIN 18381 as the general technical contractual conditions. This usually also applies as the general basis for BGB works contracts.

We recommend regulating the preventative fire protection and the execution responsibilities in writing, for instance the:

- responsibility for complying with the interface quality between buildings/building components and installations
- defining the final inspection with respect to the General Building Supervisory Authority.

The general rule is: those responsible for supply and installation are also responsible for the mortaring/interface with the building structure. The building supervisor/technical building supervisor is responsible to the General Building Supervisory Authority.

The workmen executing the job check the planning/tender to confirm compliance with the technical fire protection specifications of the planning approval/fire protection concept concerning the pipe systems. If any preventative fire protection elements are missing, it will be necessary to submit a supplementary offer. VOB-C, DIN 18381: 2002-12 stipulates that all barriers (measures implemented for fire and noise protection) should be tendered as "special work" specifying the amount and the nature of the work. It is no longer possible according to VOB-C to classify them as "extra items". It is more cost effective when preparing the execution to arrange for the installation to be executed at the same time as the preventative fire protection. Rectification is usually complicated and expensive.

ACO Haustechnik drains and rain water drainage systems include prefabricated technical fire protection solutions which require no additional assembly work and guarantee very high levels of workmanship.

6 Function of the certified ACO Haustechnik fire protection products

6.1 ACO WAL-SELECTA fire protection floor drains R 30 to R 120 with odour seals and vertical outlet sockets

The WAL-SELECTA and VARIANT- CR fire protection floor drain series are made of inflammable cast iron or stainless steel. A replaceable and retrofittable fire protection kit is fitted into the floor drains (see Fig. on P. 112). The fire protection kit varies according to the floor drain and consists of a fire protection odour seal with intumescent material in the head. This ensures safe sealing of the floor drain during a fire to prevent fires spreading from above the ceiling to below the ceiling. There is also a fire protection cartridge containing intumescent material which securely blocks off the floor drain and prevents fire spreading from beneath the ceiling to the floor above.

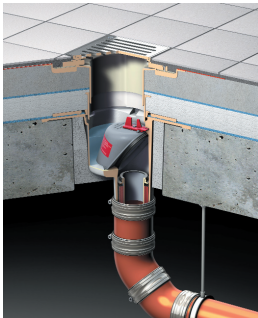

Function of the ACO Haustechnik fire protection floor drains before a fire.



A fire on top of the ceiling expands. The intumescent mass in the odour seal to completely block the drain.

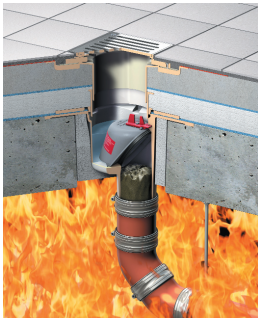

If a fire is present beneath the ceiling, the intumescent mass in the cartridge safely blocks the socket in the drain.

At temperatures of approx. 150°C, the intumescent material in the outlet socket of the floor drain expands to completely block the floor drain and prevent the spread of fire and smoke from rooms below the ceiling into rooms above the ceiling (ABZ Number Z-19.17-1527). If a fire affects the room on top of the ceiling, the intumescent mass in the odour seal expands and completely blocks the floor drain from above.

6.2 ACO WAL and VARIANT fire protection floor drains R 30 to R 120 with odour seals and horizontal outlet sockets

The WAL-SELECTA and VARIANT-CR series fire protection floor drains with horizontal outlet sockets do not require a fire protection kit. The fire protection floor drains only need to be installed 600mm from the downpipe to prevent any hot gases rising up the downpipe during a fire from boiling off the water in the odour seal. The fire protection function of this floor drain is guaranteed when they are installed in compliance with the installation instructions, and the odour trap in the drain is filled with water. The specifications are shown in Figure 9. This model is certified by MPA Dortmund, Erwitte Office and issued with a General Building Supervisory Authority Test Certificate ABP number P-MPA-E-02-005.

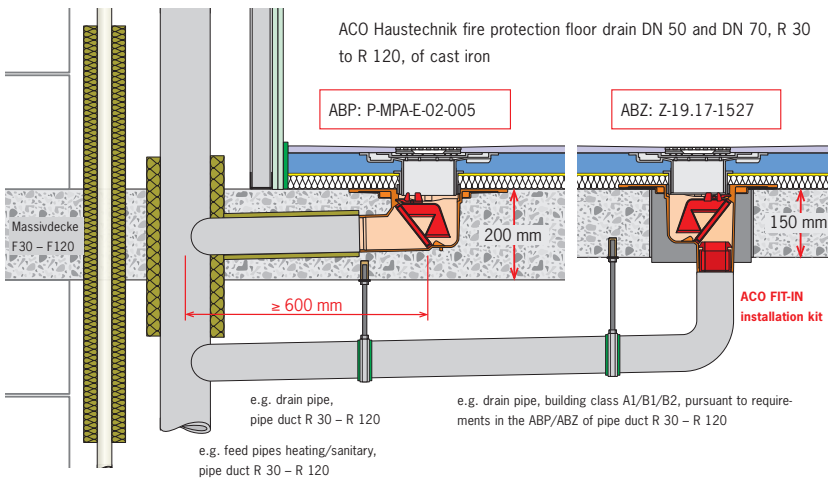

Installation examples of ACO Haustechnik WAL-SELECTA fire protection floor drain with horizontal and vertical outlet sockets.

6.3 ACO SPIN fire protection flat roof drains and fire protection multi-storey car park drains R 30 to R 120, without odour seals, with vertical outlet sockets for open-channel drainage

ACO Haustechnik SPIN flat roof drains made of inflammable cast iron can be fitted with a replaceable and retrofittable fire protection kit and intumescent mass in the socket. The fire protection fitting has four spacer feet beneath a sealing plate, which melt when the socket of the flat roof/multi-storey car park drain is exposed to temperatures of approx. 150°C. When the spacers melt, the sealing plate is pulled down by a spring mechanism to block the drain (see Figure on P. 113). This prevents the spread of smoke. At the same time, the intumescent material at the base of the fire protection fitting expands and blocks off the socket of the floor drain to prevent fire and smoke penetrating from below. These drains are suitable for installation in multi-storey car parks and flat roof ceilings without thermal insulation. This model successfully passed the fire test conducted by MPA-NRW, Erwitte Office. General Building Supervisory Authority Authorisation has been applied for from DIBT.

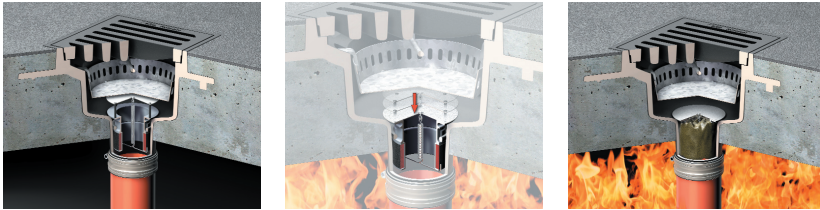

Function of the ACO Haustechnik SPIN fire protection multi-storey car park drain before a fire and during a fire.

6.4 ACO JET fire protection flat roof drains R 30 to R 120 without odour seals with vertical outlet sockets for syphonic drainage

The ACO Haustechnik JET fire protection flat roof drains are made of inflammable stainless steel, combined with a gravel trap with an air lock, and a fire and smoke seal consisting of intumescent material. The fire and smoke seal is designed so that the intumescent material in the socket of the JET fire protection flat roof drain expands at a temperature of approx. 150°C to completely seal the flat roof drain and prevent the spread of fire and smoke (see Fig. below).

The drain should be insulated with inflammable thermal insulation. This model has already successfully passed the fire test conducted by MPA/NRW, Erwitte Office. A Building Supervisory Authority Authorisation has been applied for from the German Institute for Building Technology (DIBt).

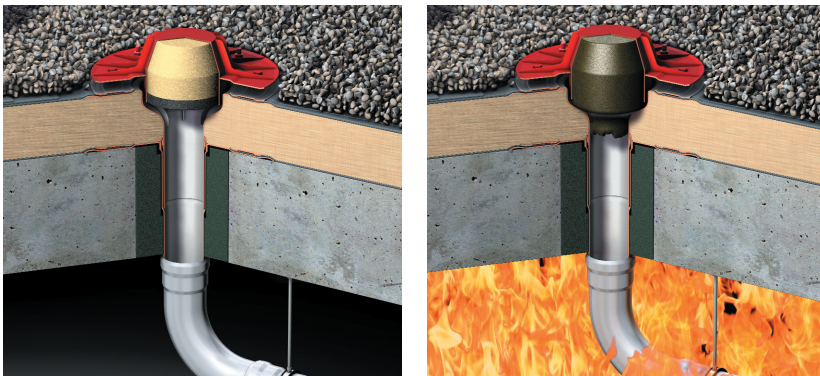

Function of the ACO JET fire protection roof drain before a fire. during a fire

6.5 ACO GM-X steel drain pipe duct fire barriers (R 30 to R 90)

ACO GM-X steel drain pipe combined with the Rockwool Conlit fire barrier system forms an R 30 to R 90 fire barrier pursuant to the Pipe and Cable System Regulations. This combination of components reduces temperature conduction during a fire down to levels that prevent secondary fires igniting on the side of the barrier facing away from the fire. Rockwool was issued with a General Building Supervisory Authority Test Certificate P-3725/4130-MPA BS for this model.

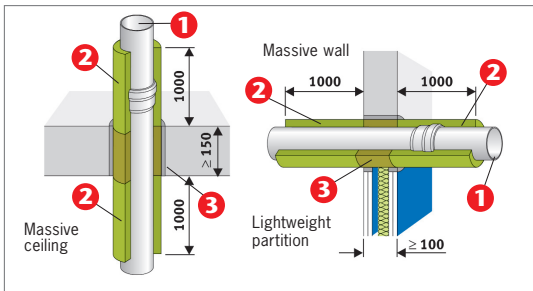

R 30 to R 90 wall and ceiling barrier

- (1) ACO GM-X steel pipe,
- (2) Insulation sleeve RS 800 (Messrs. Rockwool)
- (3) Conlit 150 U (Messrs. Rockwool)

6.6 ACO GM-X compound piping fire barriers pursuant to dispensations in MLAR/LAR/RbALei

ACO GM-X compound piping fire barriers are created using the ACO GM-X fire protection mouldings pursuant to Chapter 4.2.2 “MLAR/LAR/RbALei dispensations”.

The fire protection moulding replaces the flammable insulation at ceiling level with an integrated Conlit sleeve. The fire protection moulding (see 10.8) has a thermal and noise protection function. It can be used in all components to meet the fire resistance class specifications (minimum component thickness for F 30 = 60 mm, F 60 = 70 mm, F 90 = 80 mm).

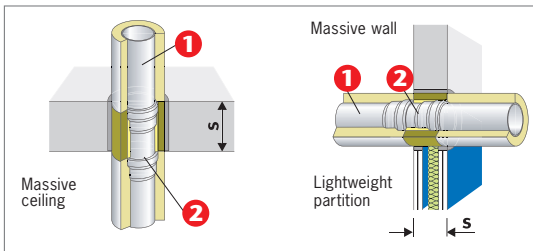

Barrier pursuant to the MLAR/LAR/RbALei dispensations

- (1) ACO GM-X compound piping
- (2) ACO GM-X fire protection moulding

Important note

The GM-X fire protection mouldings can also be used to create a fire barrier in combination with GM-X steel drain pipes in accordance with the “MLAR/LAR/RbALei dispensations”.

7. Installation of classified ACO Haustechnik fire protection products

Sealing the residual openings between fire barriers and components is done in accordance with the specifications in the General Building Supervisory Authority Authorisations (ABZ) or Test Certificates (ABP). The following can be used to seal the remaining gaps (see ABZ/ABP reference applying to each installation position) e.g.

- mortar/concrete (e.g. for dispensations)
- mortar class MG III (e.g. for old ceilings with R 30 to R 120 drains)
- filler in walls (e.g. drain pipes)

The execution of the overall fire barriers must comply with the authorisation/test certificates, Pipe and Cable System Regulations, and the installation instructions issued by the system supplier/manufacturer.

7.1 ACO WAL and VARIANT fire protection floor drains R 30 to R 120, with odour seals and vertical outlet sockets

To safely prevent fires and smoke from spreading, good workmanship is required to seal the rebate around fire protection floor drains – this is crucial. The fire protection floor drains can be installed as follows:

- by pouring them in directly when the ceiling is being constructed
- with square rebates in massive ceilings (minimum ceiling thickness 150 mm for DN 50/70/80, and 200 mm for DN 100), remaining gaps must be completely sealed by pouring in concrete in accordance with the installation instructions and specifications in ABZ or ABP.
- in massive ceilings (minimum ceiling thicknesses 100 mm for DN 50/70/80, and 150 mm for DN 100) with core boreholes and using the ACO FIT-IN installation kit. This creates a certified seal without having to seal in the floor drain with mortar (see 10.3).

Building Supervisory Authority Authorisation ABZ number. Z-19.17-1527 was issued by DIBt Berlin for this model.

7.2 ACO WAL and VARIANT fire protection floor drains R 30 to R 120 with odour seals and horizontal outlet sockets

After positioning the drain in the rebate, the fire protection floor drain must be completely sealed into the ceiling with poured concrete. The horizontal floor drains require a minimum separation of 600 mm from the centre of the down pipe to the centre of the floor drain. A safe fire barrier is created when the minimum ceiling thickness of 200 mm is complied with in accordance with the insulation instructions, and the odour seal is filled with water. General Building Supervisory Authority Test Certificate P-MPA-E-02-005 was issued for this model (see Fig. 9 Page 20).

7.3 ACO SPIN fire protection flat roof drains, R 30 to R 120 without odour seals with vertical outlet sockets for multi-storey car parks

The fire protection flat roof/multi-storey car park drain with vertical outlet sockets must be completely sealed in with mortar or poured concrete after positioning it in the rebate. The minimum ceiling thicknesses are as follows: 200 mm for SPIN flat roof drain DN 100 made of cast iron; and 150 mm for SPIN stainless steel drain DN 100. Good workmanship in sealing the rebate around the fire protection flat roof and multi-storey car park drains is crucial to safely prevent the spread of fire and smoke. Installing the drains and sealing the rebate must be carried out in compliance with the specifications and the installation instruction details.

7.4 ACO JET fire protection flat roof drains, R 30 to R 120 without odour seals with vertical outlet sockets

JET fire protection flat roof drains made of stainless steel must be completely sealed into the ceiling with poured concrete after positioning in the rebate to safely avoid the spread of fire and smoke. The minimum ceiling thickness for JET stainless steel flat roof drains DN 70 is 150 mm. Observe all of the specifications in the installation instructions.

7.5 ACO GM-X steel drain pipe fire barriers (R 30 to R 90)

Rockwool Conlit – 150-U sleeves must be used around ACO GM-X pipe which penetrates ceilings to create classified R 30 to R 90 fire barriers around the pipes. The approx. 1m long RS 800 Rockwool sleeves prevent critical temperature conduction above and below the ceilings (see 10.7). Installation must comply with the General Building Supervisory Authority Authorisation (ABZ) and the manufacturer's installation instructions.

7.6 ACO GM-X compound piping fire barriers with GM-X fire protection mouldings

The GM-X fire protection mouldings pursuant to the "MLAR/LAR/RbALei dispensations" are installed around GM-X compound piping penetrating ceilings to ensure complete technical fire protection around the ceiling duct. Mouldings must be installed in compliance with the installation instructions (see 10.8). The ACO Haustechnik fire protection mouldings comply with the Pipe and Cable System Regulations.

8. Technical fire protection documentation

All of the installed fire barriers must have the following documentation:

	Conformity declaration	Type plate	ABZ/ABP
R 30–R 120 Drain with General Building Supervisory Authorisation (ABZ)	1 conformity declaration per authorisation/ test certificate as entire document (not per drain)	yes, besides every barrier	must be present at site
R 30–R 120 Drains with General Building Supervisory test certificate (ABP)	1 conformity declaration per authorisation/ test certificate as entire document (not per drain)	no, not required	must be present at site
Pipe ducts pursuant to the MLAR/LAR/RbALEI dispensations	Expert company certificate required that MLAR/LAR/RbALEI was adhered to	no, not required	MLAR/LAR/RbALEI is known

Table of application certificates and compliance declarations after installing a fire barrier

The compliance declarations/specialist company certifications must be submitted to the building supervisor as the designated person responsible in accordance with Building Supervisory Authority law. Inspecting the documentation is delegated by the building supervisor in many cases to the technical building supervisor. The building supervisor keeps the documents together with all of the other technical fire protection documents concerning the overall building.

9 Technical fire protection inspection

The technical fire protection inspection of the building drainage systems is carried out in situ by the fire protection consultant if a technical fire protection consulting contract has been closed for the construction phase.

If such a contract has not been agreed, the building supervisor is responsible to the Building Supervisory Authority for compliance with the technical fire protection regulations. If the building supervisor is inadequately qualified for this specialisation, he can and must delegate the responsibility to a technical building supervisor (e.g. TGA technical planner). No additional inspection is required analogous to the extra inspection laid down for safety-relevant plant e.g. ventilation and emergency lighting.

10. Products and Fields of Application

10.1 ACO WAL-SELECTA fire protection floor drain

of cast iron, R 30 to R 120, with odour seal,
ABZ no.: Z-19.17-1527

Fields of application

Wet rooms in

- old people's home
- hospitals
- hotels

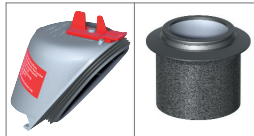

ALL-PURPOSE odour seal
Fire protection cartridge
WAL-SELECTA 70 with AV-PP

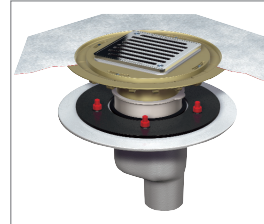

Standards/regulations

- | | |
|----------------|--|
| DIN EN 12056-2 | — Grey water plants, planning and dimensioning |
| DIN 1986-100 | — Drainage equipment for buildings and land,
additional regulations for DIN EN 752 and DIN EN 12056 |
| Data sheet | — „Notes for the design of sealings in compound system with coatings and coverings of tiles and plates for inside and outside areas“ |
| DIN 18195 | — Sealings |
| MLAR/RbALei | — Pipe Directives |
| LBO | — State building regulations of relevant German Federal state |

Suggested installation

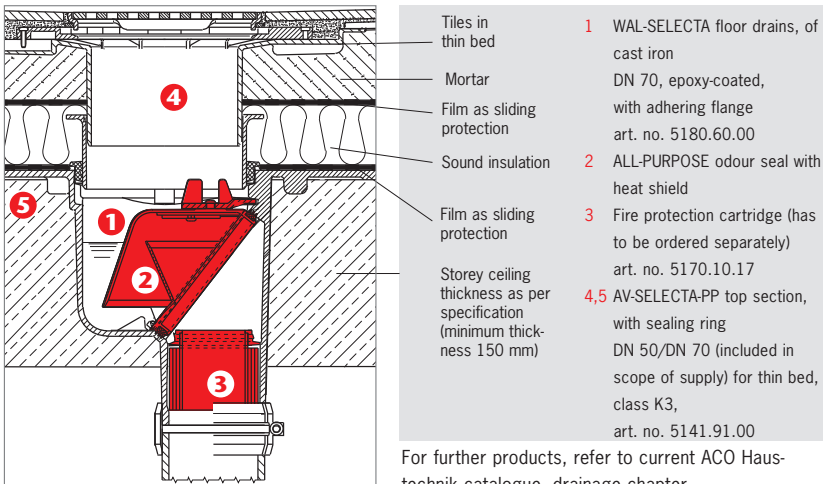

For further products, refer to current ACO Haus-technik catalogue, drainage chapter.

Installation notes

- When connecting to SML pipe DN 80, the hose element DN 70/80 art. no. 5170.70.80 has to be used (see figure).
- Without the hose element, SML pipes DN 70 can be connected directly to the floor drain.

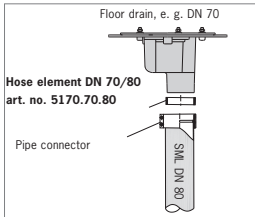

AV-SELECTA-PP top section for sealing in the thin bed process

- Following drain body installation, the sealing ring (included in scope of supply) is inserted in the drain and top section is pushed in tightly.
- Complete remaining floor structure.
- Apply sealing compound to screed and embed sealing collar (refer to installation manual and detail, figure 1).
- Complete remaining floor structure.
- The AV-SELECTA top section is telescopically height-adjustable and can be adjusted to tile thickness by means of 3 mm and 9 mm thick top frames (figure 2).
- Thanks to the special sliding flange, the grating frame can be turned and slid in all directions (figure 3).

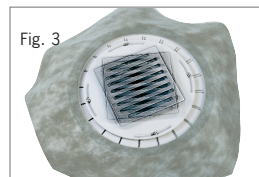
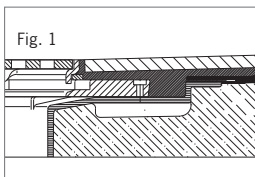

Fire protection

- The AV-SELECTA floor drain DN 70 with odour seal is equipped with a fire protection odour seal as standard feature. This is the reason why only the fire protection cartridge art. no. 5170.10.17 is required to fully comply with fire protection requirements as per ABZ. Nr. Z-19.17.1527.
- If floor drain is installed in classified fire protection ceilings, rebate must be executed in accordance with the ABZ specifications and the installation manual.
- When fitting in core boreholes, a core borehole diameter of 225 mm is required. The FIT-IN dry building kit art. no. 5170.10.40 can be used (see 10.3).

10.2 ACO VARIANT-CR fire protection floor drain

DN 100 of stainless steel, R 30 to R 120, with odour seal, ABZ no.: Z-19.17-1527

Fields of application

Wet rooms in

- kitchens
- hygienic areas
- food processing



Fire protection bell-type odour seal

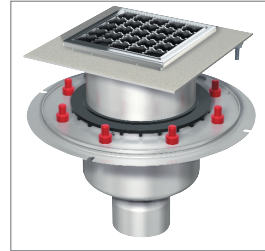

ACO VARIANT-CR floor drain DN 100

Standards/regulations

DIN EN 12056-2

- Grey water plants, planning and dimensioning

DIN 1986-100

- Drainage equipment for buildings and land, additional regulations for DIN EN 752 and DIN EN 12056

Data sheet

- „Notes for the design of sealings in compound system with coatings and coverings of tiles and plates for inside and outside areas“

DIN 18195

- Sealings

MLAR/RbALei

- Pipe Directives

Suggested installation

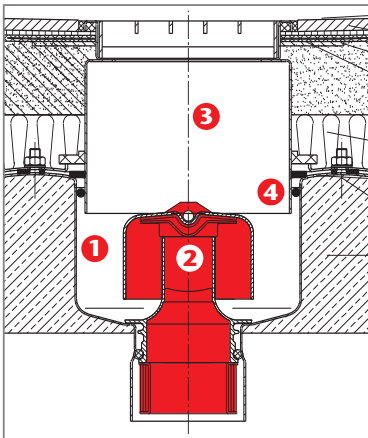

Joint
Tiles
Tile adhesive
Thin bed coating

Thermal insulation
Sealing membrane
Film as sliding protection

Storey ceiling thickness as per specification (minimum thickness 200 mm)

- 1 Stainless steel floor drain VARIANT-CR DN 100 without odour seal, art. no. 9390.10.00
- 2 Fire protection bell-type odour seal VARIANT-CR DN 100, art. no. 5087.10.15
- 3,4 Stainless steel top section AV-VARIANT with sealing ring for thin bed, class L 15, art. no. 9405.92.00

For further products, refer to current ACO Haustechnik catalogue, drainage chapter.

Installation notes

ACO VARIANT-CR fire protection floor drain DN 100

- Insert drain body in rebate and fill in remaining section in accordance with installation manual and ABZ or ABP specifications.
- Connect outlet socket with SML pipe as per DIN 19522/DIN EN 877.

AV-VARIANT stainless steel top section for sealing in the thin bed process

- Connect sealing membrane to the compression-sealing flange pursuant to DIN 18195.
- Insert the AV-VARIANT stainless steel top section in the drain body and roll in with the sealing ring, as required. If fitted properly, the sealing ring protects the floor structure from ingress of back-flowing wastewater from the pipe. At the same time, the seepage water drainage from sealing membrane into drain body is interrupted.
- Connect sealant (alternative sealing) to sanded flange to the AV-VARIANT stainless steel top section. If applicable, use sealing collar (see installation instructions).

Fire protection

- The VARIANT- CR DN 100 floor drain must be equipped with the VARIANT-CR fire protection bell-type odour seal (see Fig. on P. 120) if it is to be installed in a ceiling with a specified fire resistance class (e.g. F 30, F 60, F 90 or F 120).
- This model complies with the fire protection specifications according to ABZ number Z.19.17-1527.
- When installed in classified ceilings, the rebate must be executed in accordance with the ABZ specifications or the specifications in the installation instructions.
- A core borehole diameter of 350 mm is required if the drain is to be installed in a core borehole. In this case the FIT-IN dry building kit, art. no. 9390.10.40, can be used.
- The type plate for the fire barrier must be fixed below the ceiling (see figure below).

Rohrabschottung

System SELECTA/VARIANT-CR
Brandschutz-Bodenablauf
Feuerwiderstandsklasse
R 120, R 90 bzw. R 30
Zulassungs-Nr. Z-19.17-1527

ACO Haustechnik
ACO Passavant GmbH
D-36269 Philippsthal
Herstellungsjahr:
2005 ■, 2006 ■, 2007 ■,
2008 ■, 2009 ■

Einbau gem. den Übereinstimmungs-
nachweisen der einbau-
enden Firma.

Unterschrift _____

Type plate sample for fire barriers



ACO FIT-IN dry building kit

10.3 ACO WAL-SELECTA fire protection floor drain

DN 70 of cast iron, R 30 to R 120, with odour seal, ABZ no.: Z-19.17-1527

Fields of application

Reconstruction/change of use in hotels, old people's homes and hospitals with following components:

- Thin ceilings (100 mm)
- Cavity ceilings
- Timbered ceilings

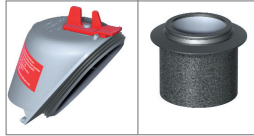

ALL-PURPOSE odour seal
Fire protection cartridge

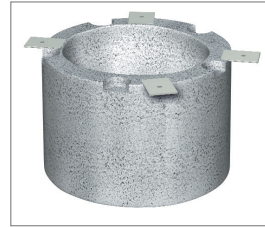

FIT-IN dry building kit

Standards/regulations

- DIN EN 12056-2 — Grey water plants, planning and dimensioning
- DIN 1986-100 — Drainage equipment for buildings and land, additional regulations for DIN EN 752 and DIN EN 12056
- Data sheet — „Notes for the design of sealings in compound system with coatings and coverings of tiles and plates for inside and outside areas“
- DIN 18195 — Sealings
- MLAR/RbALei — Pipe Directives

Suggested installation, classified ceiling 100 mm thick

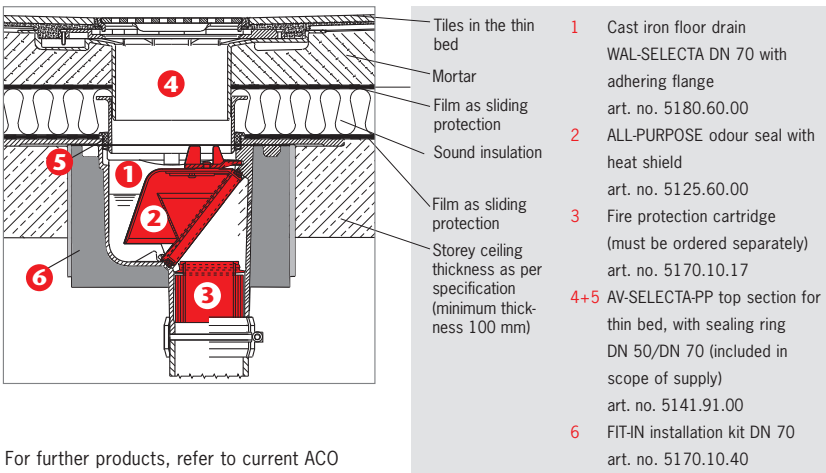

For further products, refer to current ACO Haustechnik catalogue, drainage chapter.

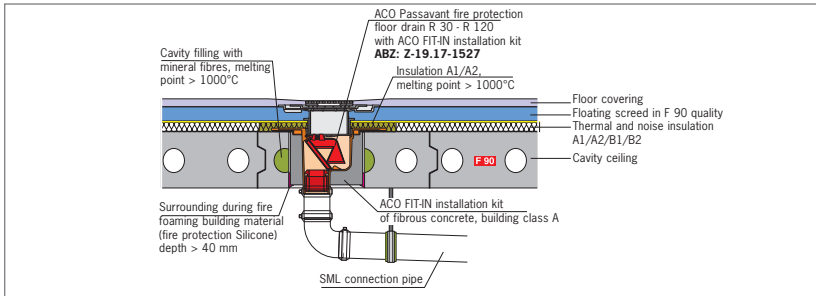
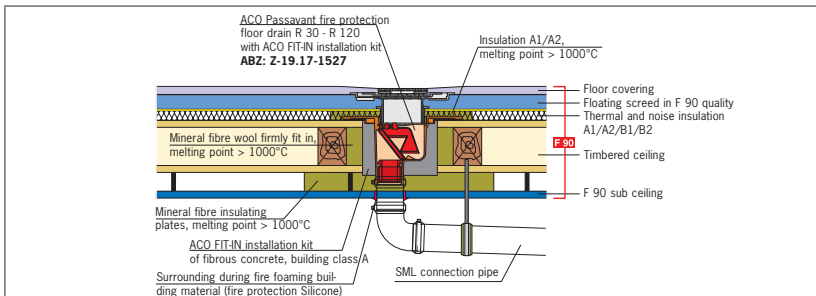
Installation notes/suggested installations
**WAL-SELECTA fire protection floor drain DN 70, R 30 to R 120
in cavity ceilings F 90**

**WAL-SELECTA fire protection floor drain DN 70, R 30 to R 120
in timbered ceilings F 90**

Fire protection

- In the case of reconstruction works or if use of existing buildings is changed, core boreholes are frequently executed when fitting fire protection floor drains in ceilings with fire resistance class F 30 to F 120.

-> The installation of ACO FIT-IN is recommended in this case.



Inserting the ACO FIT-IN installation kit



Applying the WAL-SELECTA floor drain



Connecting the SML pipe

10.4 ACO JET fire protection roof drain

R 30 to R 120, without odour seal,
for syphonic drainage
Approval applied for

Fields of application

Syphonic roof drainage for

- gravel roofs
- lightweight roofs
- large hall roofs

Standards/regulations

- | | |
|-----------------------|--|
| Flat roof regulations | — Rules for roofs with sealing |
| DIN 12056-3 | — Roof drainage, planning and dimensioning |
| DIN 1986-100 | — Drainage equipment for buildings and land |
| | Additional regulations for DIN EN 752 and DIN EN 12056 |
| VDI 3806 | — Syphonic roof drainage |
| DIN EN 1253 | — Building drains |



Suggested installation

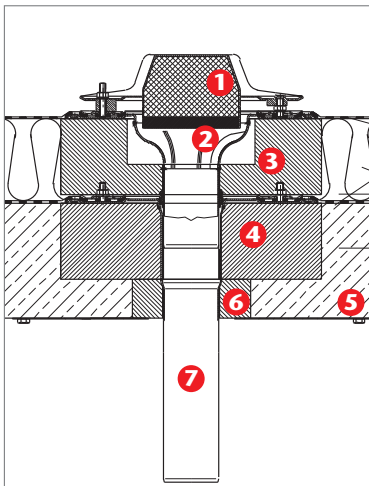

1. Gravel trap with air lock with fire protection art. no. 0174.77.03
2. JET drain body DN 70 of stainless steel art. no. 0174.46.48
3. Insulating body (drain body) art. no. 0150.12.70
4. Insulating body (bottom part) art. no. 0150.12.69
5. Heat shield with dowel art. no. 0174.77.97
6. Insulating sleeve art. no. 0174.77.93
7. JET bottom part DN 70 of stainless steel art. no. 0174.46.69

For further products, refer to current ACO Haustechnik catalogue, drainage chapter.

Installation instructions

Installation of ACO JET DN 70 bottom part

- Push the foam glass pipe shell over the JET bottom part and position it in the rebate.
- The minimum distance between the drains themselves and other components (e.g. wall connections) should be at least 30 cm pursuant to the flat roof regulations.
- If the drain is to be connected to a sealing membrane, a flange seal matching the sealing membrane type must be laid in the fixed flange according to the installation instructions before tightening up the vapour stop using the loose flange. Maximum torque $M_{\text{pge}} = 4.5 \text{ Nm}$.

ACO JET drain body DN70

- Remove the protective cover from the bottom part and insert the supplied seal.
- Push the ACO JET drain body into the ACO JET bottom part and seal it using the supplied sealing element.
- Connect the sealing membrane as described above for the ACO JET bottom part.
- After complete assembly, position the ACO JET gravel trap with the air lock, and screw it into place.

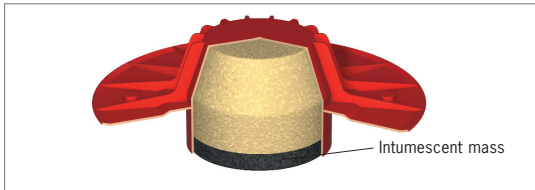

Fire protection

- The ACO JET gravel trap with air lock and fire protection fitting R 120 can be used if the ceiling drain is less than 5 m away from a rising wall. Art. no. 0174.77.03 (see Figure 38).
- The ACO JET flat roof drain DN70 with air lock, gravel trap and fire protection insert has already been successfully tested by the MPA-NRW Erwitte office and is suitable for installation in flat roofs with fire resistance classes up to R 120.
- An ABZ has been applied for from the German Institute for Building Technology, Berlin (DIBt).

10.5 ACO SPIN fire protection multi-storey car park drain

DN 100, R 30 to R 120, without odour seal,
Approval applied for

Fields of application

Open-channel roof drainage for

- car park decks
- multi-storey car park buildings

Standards/regulations

- | | |
|-----------------------|---|
| Flat roof regulations | — Rules for roofs with sealing |
| DIN 12056-3 | — Roof drainage, planning and dimensioning |
| DIN 1986-100 | — Drainage equipment for buildings and land
Additional regulations for DIN EN 752 and DIN EN 12056 |
| DIN 18195 | — Construction sealing |
| DIN EN 1253 | — Building drains |



Suggested installation

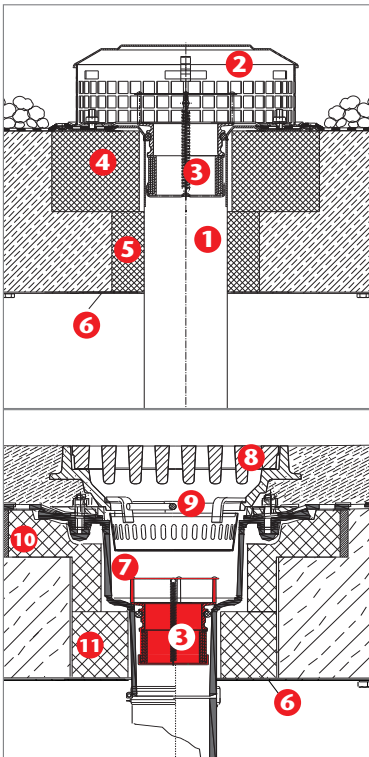

- 1+2 SPIN flat roof drain DN 100 single-part design, of stainless steel and gravel trap art. no. 0174.47.38
- 3 Fire protection insert art. no. 7034.20.15
- 4 Foamglass insulating body art. no. 0174.77.96
- 5 Foamglass insulating body art. no. 0174.77.94
- 6 Metal plate with dowels and bolts art. no. 7034.20.17
- 7 SPIN flat roof drain DN 100, single-part design, of cast iron art. no. 7034.10.10
- 8 Top frame with grating class M 125 art. no. 7000.42.00
- 9 Bucket art. no. 7000.13.00
- 10 Foamglass insulating body art. no. 7040.21.00
- 11 Foamglass insulating body art. no. 7040.23.00

Installation instructions

- The minimum distance between the drains themselves and other components (e.g. wall connections) should be at least 30 cm pursuant to the flat roof regulations
- Lay the seal on the fixed flange (adhering flange) in accordance with the flat roof regulations and the relevant standards and regulations, and tighten up with the loose flange (Figure 41).
- An intermediate layer should be used when laying thin roof-sealing membranes in SPIN cast iron flat roof drains.
- The multi-storey car park/flat roof drain should be positioned within the rebate and completely sealed in with poured concrete.

Fire protection

- If the multi-storey car park/flat roof drain is located in the ceiling of the highest car parking level, and is closer than 5 m to a rising wall, use fire protection insert art. no 7034.20.15 in the drain. This fitting reduces the flow capacity of the drain by around 1 l/s.
- The ACO SPIN flat roof drain DN 100 with fire protection insert has already been successfully tested by the MPA-NRW Dortmund Erwitte office as suitable for installation in flat roofs with fire resistance classes up to R 120.
- The ABZ has been applied for from the German Institute for Building Technology, Berlin (DIBt).
- The insulation housing is pushed over the socket from below.
- The metal plate with the plugs and screws (supplied as standard) is screwed into the ceiling from below. It can also be used as disposable shuttering to fill the rebate.
- Screwing down the metal plates avoids direct contact between the fire and the foamglass.

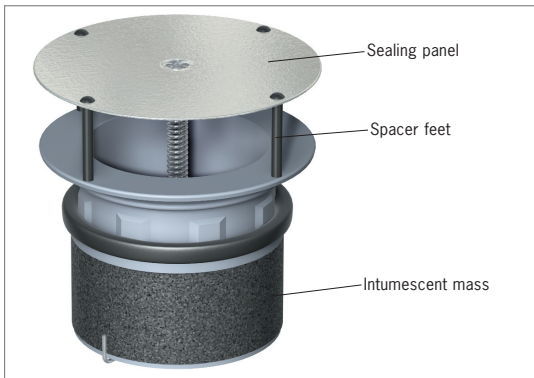

Fire protection insert

For further products, refer to current ACO Haustechnik catalogue, drainage chapter.

10.6 ACO fire protection multi-storey car park drain

DN 100, R 30 to R 120, without odour seal,
Approval applied for

Fields of application

Drainage of

- car park decks
- multi-storey car park buildings
- open tribunes in stadiums



Standards/regulations

- DIN 12056-3 — Roof drainage, planning and dimensioning
DIN 1986-100 — Drainage equipment for buildings and land
Additional regulations for DIN EN 752 and DIN EN 12056
GVO — Garage Directive of Federal states, fire protection
LBO — State building regulation of Federal states, fire protection

Suggested installation

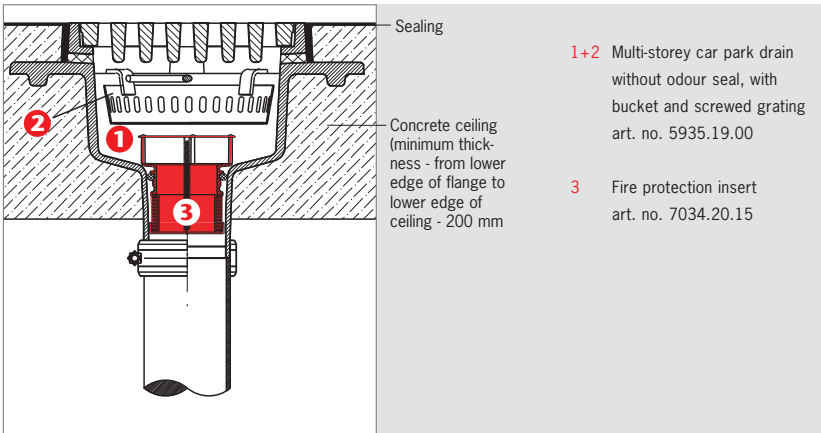

For further products, refer to current ACO Haustechnik catalogue, drainage chapter.

Installation instructions

- Multi-storey car park drains are usually poured in directly when the ceilings are constructed or are positioned in rebates before being completely sealed in with poured concrete.
- Use of multi-storey car park drains with a holding edge/connecting rim is recommended to improve the bonding between the drain and the ceiling.
- Connect the outflow socket with SML pipe pursuant to DIN 19522/DIN EN 877.

Fire protection

- If the roof drain is closer than 5 m to a rising wall, use the fire protection insert art. no. 7034.20.15 in the drain.
- The fitting reduces the outflow capacity of the drain (technical details upon request).
- The ACO multi-storey car park fire protection floor drain DN 100 with fire protection insert has already been successfully tested by MPA-NRW Dortmund, Erwitte office, and is suitable for use in flat roofs with fire resistance classes up to R 120.
- The ABZ has been applied for from the German Institute for Building Technology, Berlin (DIBt).

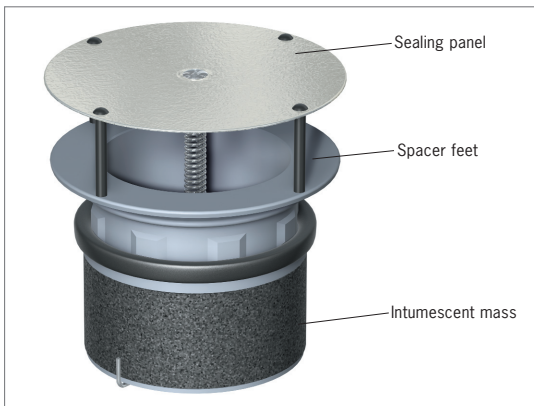

Fire protection insert

10.7 ACO GM-X steel drain pipe

for internal wastewater pipes,
 wall and ceiling pipe barrier R 30 to R 90
 ABP: P-3725/4130-MPA BS (Messrs. Rockwool)

Fields of application

Ceilings and walls with fire resistance class



Standards/regulations

- | | |
|----------------|---|
| DIN EN 12056-2 | — Grey water plants, planning and dimensioning |
| DIN EN 12056-3 | — Roof drainage, planning and dimensioning |
| DIN 1986-100 | — Drainage equipment for buildings and land |
| | Additional regulations for DIN EN 752 and DIN EN 12056 |
| DIN EN 1123 | — Pipes and fittings of hot-galvanised steel pipes with push sockets for wastewater pipes |

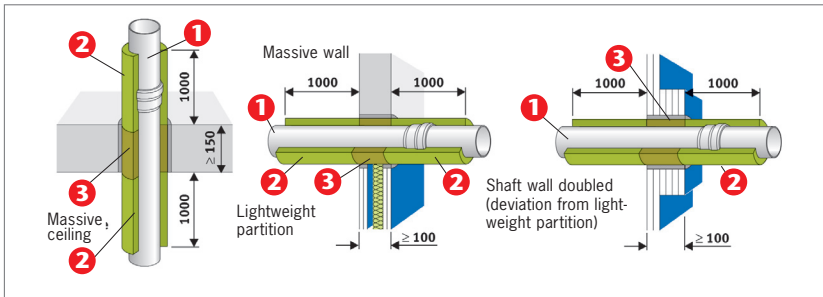

- 1 ACO GM-X steel drain pipe
- 2 Insulation sleeve RS 800 (Messrs. Rockwool)
- 3 Conlit 150 U (Messrs. Rockwool)

For further products, refer to current ACO Haustechnik catalogue, drainage chapter.

Models in accordance with Rockwool ABP P-3725/4130-MPA BS

System	Pipe dimensions		Conlit sleeve 150 U			Insulating sleeve RS 800 ¹⁾²⁾	
	External DN diameter		Type ³⁾	Insulation thickness ⁴⁾	Core-Dk	Type	Insulation thickness
	Da (mm)		s (mm)	(mm)			s (mm)
GM-X	42	40	42/29	29	100	42/30	30
GM-X	53	50	53/23.5	23.5	100	54/30	30
GM-X	73	70	73/38.5	38.5	150	76/30	30
GM-X	89	80	89/30.5	30.5	150	89/30	30
GM-X	102	100	102/39	39	180	102/30	30
GM-X	133	125	133/43.5	43.5	220	133/40	40
GM-X	159	150	159/30.5	30.5	220	159/40	40
GM-X	219	200	219/40	40	319	219/40 ⁵⁾	40

¹⁾ Insulation sleeve RS 800 with aluminium laminated foil pursuant to DIN 1986-100 required as a vapour barrier.

²⁾ The remaining gap up to the core borehole must be completely sealed with Conlit fire protection mastic (max gap 30 mm).

³⁾ Fire protection pipe sleeve Conlit 150 U with aluminium laminated foil pursuant to DIN 1986-100 necessary as a vapour barrier.

⁴⁾ Insulation thickness matching the core borehole diameter Dk.

⁵⁾ For R 90, insulation L 4 should extend for at least 1500 mm.

All of the conditions of the specified General Building Supervisory Authority Test Certificates (ABP) must be observed.

10.8 ACO GM-X compound piping

for internal wastewater pipes,
wall and ceiling pipe barrier R 30 to R 90

Fields of application

Ceilings and walls with fire resistance class



Standards/regulations

- DIN EN 12056-2 — Grey water plants, planning and dimensioning
- DIN EN 12056-3 — Roof drainage, planning and dimensioning
- DIN 1986-100 — Drainage equipment for buildings and land
Additional regulations for DIN EN 752 and DIN EN 12056
- DIN EN 1123 — Pipes and fittings of hot-galvanised steel pipes with push sockets for
wastewater pipes

Suggested installation

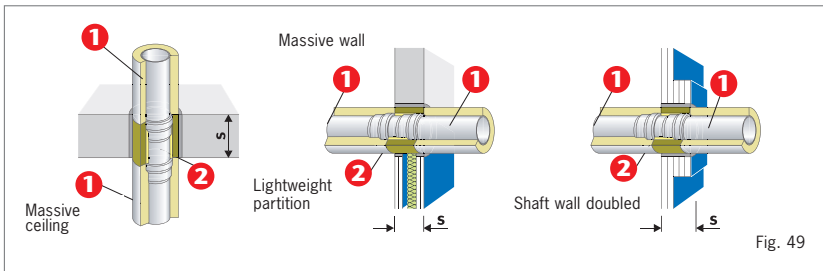

- 1 ACO GM-X compound piping
- 2 ACO GM-X fire protection moulding

For further products, refer to current ACO Haustechnik catalogue, drainage chapter.

Installation instructions

- ACO GM-X fire protection mouldings (Figure 50) must be used for ducts with ACO GM-X compound piping DN 40 to DN 150.
- Installation possible in ceilings and walls with fire resistance classes F 30 to F 90.
- The minimum thickness of the walls and ceilings must not be undercut (see table).

Ceiling or wall	Minimum thickness s
F 30	60 mm
F 60	70 mm
F 90	80 mm

- The separation between two pipes must be larger than 50 mm in the case of insulated single pipes with inflammable insulation if no other distances are specified by ABZ or ABP.
- The necessary insulation thickness and insulation length required for installation is specified in the aforementioned table and in the installation example details.
- All of the specifications in the Building Supervisory Authority Test Certificates must be observed.

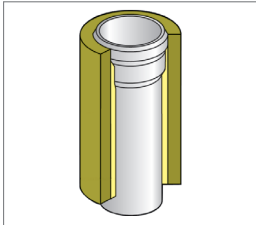

Fire protection moulding